

# UCC28180 Programmable Frequency, Continuous Conduction Mode (CCM), Boost Power Factor Correction (PFC) Controller

## 1 Features

- 8-Pin Solution (No AC Line Sensing Needed)
- Wide Range Programmable Switching Frequency (18 kHz to 250 kHz for MOSFET and IGBT-based PFC Converters)
- Trimmed Current Loop Circuits for Low iTHD
- Reduced Current Sense Threshold (Minimizes Power Dissipation in Shunt)
- Average Current-Mode Control
- Soft Over Current and Cycle-by-Cycle Peak Current Limit Protection
- Output Overvoltage Protection With Hysteresis Recovery
- Audible Noise Minimization Circuitry
- Open Loop Detection
- Enhance Dynamic Response During Output Overvoltage and Undervoltage Conditions
- Maximum Duty Cycle of 96% (Typical)
- Burst Mode for No Load Regulation
- VCC UVLO, Low ICC Start-Up ( $< 75 \mu\text{A}$ )

## 2 Applications

- Universal AC Input, CCM Boost PFC Converters in 100-W to Few-kW Range
- Server and Desktop Power Supplies
- White Good Appliances (Air Conditioners, Refrigerators)
- Industrial Power Supplies (DIN Rail)
- Flat Panel (PDP, LCD, and LED) TVs

## 3 Description

The UCC28180 is a flexible and easy-to-use, 8-pin, active Power-Factor Correction (PFC) controller that operates under Continuous Conduction Mode (CCM) to achieve high Power Factor, low current distortion and excellent voltage regulation of boost pre-regulators in AC - DC front-ends. The controller is suitable for universal AC input systems operating in 100-W to few-kW range with the switching frequency programmable between 18 kHz to 250 kHz, to conveniently support both power MOSFET and IGBT switches. An integrated 1.5-A and 2-A (SRC-SNK) peak gate drive output, clamped internally at 15.2 V (typical), enables fast turn-on, turn-off, and easy management of the external power switch without the need for buffer circuits.

Low-distortion wave shaping of the input current using average current mode control is achieved without input line sensing, reducing the external component count. In addition, the controller features reduced current sense thresholds to facilitate the use of small-value shunt resistors for reduced power dissipation, especially important in high-power systems. To enable low current distortion, the controller also features trimmed internal current loop regulation circuits for eliminating associated inaccuracies.

### Device Information<sup>(1)</sup>

| PART NUMBER | PACKAGE  | BODY SIZE (NOM)   |
|-------------|----------|-------------------|
| UCC28180    | SOIC (8) | 4.90 mm x 3.91 mm |

(1) For all available packages, see the orderable addendum at the end of the datasheet.

### Typical Application Schematic

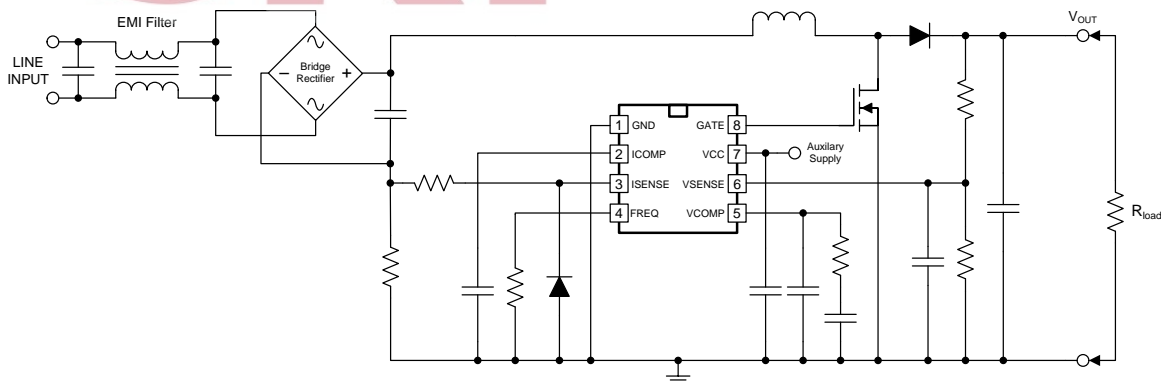

Copyright © 2016, Texas Instruments Incorporated



An IMPORTANT NOTICE at the end of this data sheet addresses availability, warranty, changes, use in safety-critical applications, intellectual property matters and other important disclaimers. PRODUCTION DATA

## Table of Contents

|  |    |  |    |
|--|----|--|----|
| <b>1 Features</b> .....                        | 1  | 8.4 Device Functional Modes.....                                 | 20 |
| <b>2 Applications</b> .....                    | 1  | <b>9 Application and Implementation</b> .....                    | 21 |
| <b>3 Description</b> .....                     | 1  | 9.1 Application Information.....                                 | 21 |
| <b>4 Revision History</b> .....                | 2  | 9.2 Typical Application .....                                    | 22 |
| <b>5 Description (Continued)</b> .....         | 3  | <b>10 Power Supply Recommendations</b> .....                     | 36 |
| <b>6 Pin Configuration and Functions</b> ..... | 4  | 10.1 Bias Supply .....   | 36 |
| <b>7 Specifications</b> .....                  | 5  | <b>11 Layout</b> .....   | 36 |
| 7.1 Absolute Maximum Ratings .....             | 5  | 11.1 Layout Guidelines .....                                     | 36 |
| 7.2 ESD Ratings .....                          | 5  | 11.2 Layout Example .....  | 38 |
| 7.3 Recommended Operating Conditions.....      | 5  | <b>12 Device and Documentation Support</b> .....                 | 39 |
| 7.4 Thermal Information .....                  | 5  | 12.1 Documentation Support .....                                 | 39 |
| 7.5 Electrical Characteristics.....            | 6  | 12.2 Receiving Notification of Documentation Updates             | 39 |
| 7.6 Typical Characteristics.....               | 8  | 12.3 Community Resources.....                                    | 39 |
| <b>8 Detailed Description</b> .....            | 12 | 12.4 Trademarks.....   | 39 |
| 8.1 Overview .....                             | 12 | 12.5 Electrostatic Discharge Caution.....                        | 39 |
| 8.2 Functional Block Diagram .....             | 13 | 12.6 Glossary .....  | 39 |
| 8.3 Feature Description.....                   | 14 | <b>13 Mechanical, Packaging, and Orderable Information</b> ..... | 39 |

## 4 Revision History

| Changes from Revision C (April 2016) to Revision D   | Page |
|--|------|
| • Changed the correct page number in the C Revision History of the diode addition to the Functional Block Diagram.....   | 2    |
| • Changed text value of 0.538 to 0.366 to align with <a href="#">Equation 85</a> . Updated change was implemented in the C revision and recorded in the D revision. .... | 31   |
| • Added D4 to <a href="#">Table 2</a> . Updated change was implemented in the C revision and recorded in the D revision. ....  | 37   |
| • Added <a href="#">Receiving Notification of Documentation Updates</a> .....  | 39   |
| • Added <a href="#">Community Resources</a> .....  | 39   |

| Changes from Revision B (December 2014) to Revision C   | Page |
|---|------|
| • Added a diode to the Typical Application Schematic image. ....                              | 1    |
| • Changed ICC Standby current MAX rate from 2.95 mA to 3.47 mA.....                           | 6    |
| • Changed ISENSE threshold, soft over current (SOC) TYP value from –0.295 V to –0.285 V. .... | 6    |
| • Changed Maximum current under EDR operation MAX rating from –241 µA to –275 µA. ....        | 6    |
| • Added a diode to the Functional Block Diagram. ....   | 13   |
| • Added Diode to Soft Overcurrent/Peak-Current Limit image. ....                              | 17   |
| • Added ISENSE Pin section. ....  | 18   |
| • Added diode to the Design Example Schematic image. ....                                     | 22   |
| • Changed <a href="#">Equation 101</a> 3kHz to 5kHz. ....                                     | 32   |
| • Changed Recommended Layout for UCC28180 image.....  | 38   |

| Changes from Revision A (November 2013) to Revision B   | Page |
|---|------|
| • Added <i>ESD Rating table, Feature Description section, Device Functional Modes, Application and Implementation section, Power Supply Recommendations section, Layout section, Device and Documentation Support section, and Mechanical, Packaging, and Orderable Information section</i> ..... | 1    |

## 5 Description (Continued)

Simple external networks allow for flexible compensation of the current and voltage control loops. In addition, UCC28180 offers an enhanced dynamic response circuit that is based on the voltage feedback signal to deliver improved response under fast load transients, both for output overvoltage and undervoltage conditions. An unique VCOMP discharge circuit provided in UCC28180 is activated whenever the voltage feedback signal exceeds  $V_{OVP\_L}$  thus allowing a chance for the control loop to stabilize quickly and avoid encountering the overvoltage protection function when PWM shutoff can often cause audible noise. Controlled soft start gradually regulates the input current during start-up and reduces stress on the power switches. Numerous system-level protection features available in the controller include VCC UVLO, peak current limit, soft overcurrent, output open-loop detection, output overvoltage protection and open-pin detection (VISNS). A trimmed internal reference provides accurate protection thresholds and regulation set-point. The user can control low-power standby mode by pulling the VSENSE pin below 0.82 V.



## 6 Pin Configuration and Functions

8-Pin SOIC  
D Package  
(TOP VIEW)

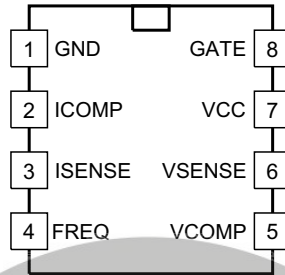

Pin Functions

| PIN    |     | I/O | DESCRIPTION   |
|--------|-----|-----|---|
| NAME   | NO. |     |   |
| GATE   | 8   | O   | <b>Gate Drive:</b> Integrated push-pull gate driver for one or more external power MOSFETs. Typical 2.0-A sink and 1.5-A source capability. Output voltage is typically clamped at 15.2 V (typical).  |
| GND    | 1   |     | <b>Ground:</b> device ground reference.   |
| ICOMP  | 2   | O   | <b>Current Loop Compensation:</b> Transconductance current amplifier output. A capacitor connected to GND provides compensation and averaging of the current sense signal in the current control loop. The controller is disabled if the voltage on ICOMP is less than 0.2 V, (ICOMPP protection function).   |
| ISENSE | 3   | I   | <b>Inductor Current Sense:</b> Input for the voltage across the external current sense resistor, which represents the instantaneous current through the PFC boost inductor. This voltage is averaged by the current amplifier to eliminate the effects of ripple and noise. <i>Soft Over Current (SOC)</i> limits the average inductor current. <i>Cycle-by-cycle peak current limit (PCL)</i> immediately shuts off the GATE drive if the peak-limit voltage is exceeded. An internal 2.3- $\mu$ A current source pulls ISENSE above 0.085 V to shut down PFC operation if this pin becomes open-circuited, (ISOP protection function). Use a 220- $\Omega$ resistor between this pin and the current sense resistor to limit inrush-surge currents into this pin.   |
| VCC    | 7   |     | <b>Device Supply:</b> External bias supply input. <i>Under-Voltage Lockout (UVLO)</i> disables the controller until VCC exceeds a turn-on threshold of 11.5 V. Operation continues until VCC falls below the turn-off (UVLO) threshold of 9.5 V. A ceramic by-pass capacitor of 0.1 $\mu$ F minimum value should be connected from VCC to GND as close to the device as possible for high-frequency filtering of the VCC voltage.   |
| VCOMP  | 5   | O   | <b>Voltage Loop Compensation:</b> Transconductance voltage error amplifier output. A resistor-capacitor network connected from this pin to GND provides compensation. VCOMP is held at GND until VCC, and VSENSE exceed their threshold voltages. Once these conditions are satisfied, VCOMP is charged until the VSENSE voltage reaches its nominal regulation level. When Enhanced Dynamic Response (EDR) is engaged, a higher transconductance is applied to VCOMP to reduce the charge or discharge time for faster transient response. <i>Soft Start</i> is programmed by the capacitance on this pin. VCOMP is pulled low when VCC UVLO, OLP/Standby, ICOMPP and ISOP functions are activated.  |
| FREQ   | 4   | O   | <b>Switching Frequency Setting:</b> This pin allows the setting of the operating switching frequency by connecting a resistor to ground. The programmable frequency range is from 18 kHz to 250 kHz.  |
| VSENSE | 6   | I   | <b>Output Voltage Sense:</b> An external resistor-divider network connected from this pin to the PFC output voltage provides feedback sensing for regulation to the internal 5-V reference voltage. A small capacitor from this pin to GND filters high-frequency noise. Standby disables the controller and discharges VCOMP when the voltage at VSENSE drops below the Open-Loop Protection (OLP) threshold of 16.5% $V_{REF}$ (0.82 V). An internal 100-nA current source pulls VSENSE to GND during pin disconnection. <i>Enhanced Dynamic Response (EDR)</i> rapidly returns the output voltage to its normal regulation level when a system line or load step causes VSENSE to rise above 105% or fall below 95% of the reference voltage. Two level <i>Output Over-Voltage Protection (OVP)</i> : a 4-k $\Omega$ resistor connects VCOMP to ground to rapidly discharge VCOMP when VSENSE exceeds 107% ( $V_{OVP\_L}$ ) of the reference voltage. If VSENSE exceeds 109% ( $V_{OVP\_H}$ ) of the reference voltage, GATE output will be disabled until VSENSE drops below 102% of the reference voltage. |

## 7 Specifications

### 7.1 Absolute Maximum Ratings<sup>(1)</sup>

Over operating free-air temperature range, all voltages are with respect to GND (unless otherwise noted). Currents are positive into and negative out of the specified terminal.

|                                       |                            | MIN  | MAX | UNIT |
|---------------------------------------|----------------------------|------|-----|------|
| Input voltage range                   | VCC, GATE                  | -0.3 | 22  | V    |
|                                       | FREQ, VSENSE, VCOMP, ICOMP | -0.3 | 7   |      |
| Input current range                   | ISENSE                     | -24  | 7   |      |
|                                       | VSENSE, ISENSE             | -1   | 1   | mA   |
| Junction temperature, T <sub>J</sub>  | Operating                  | -55  | 150 | °C   |
| Lead temperature, T <sub>SOL</sub>    | Soldering, 10 s            |      | 300 | °C   |
| Storage temperature, T <sub>stg</sub> |                            | -65  | 150 | °C   |

- (1) Stresses beyond those listed under “absolute maximum ratings” may cause permanent damage to the device. These are stress ratings only and functional operation of the device at these or any other condition beyond those included under “recommended operating conditions” is not implied. Exposure to absolute-maximum-rated conditions for extended periods of time may affect device reliability.

### 7.2 ESD Ratings

|  |  | VALUE | UNIT |
|--|--|-------|------|
| V <sub>(ESD)</sub> Electrostatic discharge | Human-body model (HBM), per ANSI/ESDA/JEDEC JS-001 <sup>(1)</sup>              | ±2000 | V    |
|  | Charged-device model (CDM), per JEDEC specification JESD22-C101 <sup>(2)</sup> | ±500  |      |

- (1) JEDEC document JEP155 states that 500-V HBM allows safe manufacturing with a standard ESD control process.  
(2) JEDEC document JEP157 states that 250-V CDM allows safe manufacturing with a standard ESD control process.

### 7.3 Recommended Operating Conditions

over operating free-air temperature range (unless otherwise noted)

|  | MIN                     | MAX | UNIT |
|--|-------------------------|-----|------|
| VCC input voltage from a low-impedance source  | VCC <sub>OFF</sub> + 1V | 21  | V    |
| Operating junction temperature, T <sub>J</sub> | -40                     | 125 | °C   |
| Operating frequency                            | 18                      | 250 | kHz  |

### 7.4 Thermal Information

| THERMAL METRIC <sup>(1)</sup> |   | UCC28180 |        | UNIT |
|-------------------------------|---|----------|--------|------|
|                               |   | D        | 8 PINS |      |
| R <sub>θJA</sub>              | Junction-to-ambient thermal resistance <sup>(2)</sup>       | 116.1    |        | °C/W |
| R <sub>θJctop</sub>           | Junction-to-case (top) thermal resistance <sup>(3)</sup>    | 62.2     |        |      |
| R <sub>θJB</sub>              | Junction-to-board thermal resistance <sup>(4)</sup>         | 56.4     |        |      |
| ψ <sub>JT</sub>               | Junction-to-top characterization parameter <sup>(5)</sup>   | 14.4     |        |      |
| ψ <sub>JB</sub>               | Junction-to-board characterization parameter <sup>(6)</sup> | 55.9     |        |      |

- (1) For more information about traditional and new thermal metrics, see the *Semiconductor and IC Package Thermal Metrics* application report (SPRA953).  
(2) The junction-to-ambient thermal resistance under natural convection is obtained in a simulation on a JEDEC-standard, high-K board, as specified in JESD51-7, in an environment described in JESD51-2a.  
(3) The junction-to-case (top) thermal resistance is obtained by simulating a cold plate test on the package top. No specific JEDEC-standard test exists, but a close description can be found in the ANSI SEMI standard G30-88.  
(4) The junction-to-board thermal resistance is obtained by simulating in an environment with a ring cold plate fixture to control the PCB temperature, as described in JESD51-8.  
(5) The junction-to-top characterization parameter, ψ<sub>JT</sub>, estimates the junction temperature of a device in a real system and is extracted from the simulation data for obtaining R<sub>θJA</sub>, using a procedure described in JESD51-2a (sections 6 and 7).  
(6) The junction-to-board characterization parameter, ψ<sub>JB</sub>, estimates the junction temperature of a device in a real system and is extracted from the simulation data for obtaining R<sub>θJA</sub>, using a procedure described in JESD51-2a (sections 6 and 7).

## 7.5 Electrical Characteristics

Unless otherwise noted, VCC=15Vdc, 0.1µF from VCC to GND,  $-40^{\circ}\text{C} \leq T_J = T_A \leq +125^{\circ}\text{C}$ . All voltages are with respect to GND. Currents are positive into and negative out of the specified terminal.

| PARAMETER                           |  | TEST CONDITIONS                            | MIN    | TYP    | MAX    | UNIT              |
|-------------------------------------|--|--|--------|--------|--------|-------------------|
| <b>VCC BIAS SUPPLY</b>              |  |  |        |        |        |                   |
| ICC <sub>PRESTART</sub>             | ICC Pre-start current  | VCC = VCC <sub>OFF</sub> – 0.2 V           |        |        | 75     | µA                |
| ICC <sub>STBY</sub>                 | ICC Standby current  | VSENSE = 0.5 V                             | 1.8    | 2.4    | 3.47   | mA                |
| ICC <sub>ON_load</sub>              | ICC Operating current  | VSENSE = 4.0 V, C <sub>GATE</sub> = 4.7 nF | 5.8    | 7      | 8.8    | mA                |
| <b>UNDER VOLTAGE LOCKOUT (UVLO)</b> |  |  |        |        |        |                   |
| VCC <sub>ON</sub>                   | VCC Turn on threshold  |  | 10.8   | 11.5   | 12.1   | V                 |
| VCC <sub>OFF</sub>                  | VCC Turn off threshold   |  | 9.1    | 9.5    | 10.3   | V                 |
|                                     | UVLO Hysteresis  |  | 1.6    | 1.7    | 2      | V                 |
| <b>VARIABLE FREQUENCY</b>           |  |  |        |        |        |                   |
| f <sub>SW</sub>                     | Minimum switching frequency  | R <sub>FREQ</sub> = 130 kΩ                 | 16.3   | 18     | 19.8   | kHz               |
|                                     | Typical switching frequency  | R <sub>FREQ</sub> = 32.7 kΩ                | 61.75  | 65     | 68.25  | kHz               |
|                                     | Maximum switching frequency  | R <sub>FREQ</sub> = 8.2 kΩ                 | 225    | 250    | 275    | kHz               |
| V <sub>FREQ</sub>                   | Voltage at FREQ pin  | T <sub>A</sub> = 25°C                      | 1.43   | 1.5    | 1.56   | V                 |
| <b>PWM</b>                          |  |  |        |        |        |                   |
| D <sub>MIN</sub>                    | Minimum duty cycle   | VSENSE = 5.1 V, ISENSE = –0.25 V           |        |        | 0%     |                   |
| D <sub>MAX</sub>                    | Maximum duty cycle   | VSENSE = 4.0 V, R <sub>FREQ</sub> = 32.7 Ω | 94.8%  | 96.5%  | 98%    |                   |
| t <sub>OFF(min)</sub>               | Minimum off time   | VSENSE = 3 V, I <sub>COMP</sub> = 0.72 V   | 450    | 570    | 690    | ns                |
| <b>SYSTEM PROTECTION</b>            |  |  |        |        |        |                   |
| V <sub>SOC</sub>                    | ISENSE threshold, soft over current (SOC)  |  | –0.259 | –0.285 | –0.312 | V                 |
| V <sub>PCL</sub>                    | ISENSE threshold, peak current limit (PCL)   |  | –0.345 | –0.4   | –0.438 | V                 |
| I <sub>ISOP</sub>                   | ISENSE bias current, ISENSE open-pin protection (ISOP)   | ISENSE = 0 V                               |        | –2.3   | –2.95  | µA                |
| V <sub>ISOP</sub>                   | ISENSE threshold, ISENSE open-pin protection (ISOP)  | ISENSE = open pin                          |        | 0.085  | 0.14   | V                 |
| V <sub>OLP</sub>                    | VSENSE threshold, open loop protection (OLP)   | ICOMP = 1 V, ISENSE = 0 V                  | 15.6   | 16.5   | 17.6   | %V <sub>REF</sub> |
|                                     | Open loop protection (OLP) Internal pull-down current  | VSENSE = 0.5 V                             |        | 100    | 325    | nA                |
| V <sub>UVD</sub>                    | VSENSE threshold, output under-voltage detection (UVD) used for enhanced dynamic response <sup>(1)</sup>             |  | 93.25  | 95     | 97     | %V <sub>REF</sub> |
| V <sub>OVD</sub>                    | VSENSE threshold, output over-voltage detection (OVD) used for Enhanced dynamic response <sup>(1)</sup>              |  | 103    | 105    | 106.75 | %V <sub>REF</sub> |
| V <sub>OVP_L</sub>                  | Output over-voltage protection low threshold, VCOMP is discharged by a 4kΩ resistor when VSENSE > V <sub>OVP_L</sub> |  | 105    | 107    | 109    | %V <sub>REF</sub> |
| V <sub>OVP_H</sub>                  | Output over-voltage protection high threshold, PWM shuts off when VSENSE > V <sub>OVP_H</sub>                        |  | 107    | 109    | 111    | %V <sub>REF</sub> |
| V <sub>OVP_H(RST)</sub>             | Output over-voltage protection (VOVP_H) reset threshold, PWM turns on when VSENSE < V <sub>OVP_H(RST)</sub>          |  | 100    | 102    | 104    | %V <sub>REF</sub> |
|                                     | ICOMP threshold, external overload protection  |  |        | 0.2    | 0.25   | %V <sub>REF</sub> |
| <b>CURRENT LOOP</b>                 |  |  |        |        |        |                   |
| g <sub>mi</sub>                     | Transconductance gain  |  | 0.75   | 0.95   | 1.1    | mS                |
|                                     | Output linear range <sup>(1)</sup>   |  |        | ±50    |        | µA                |
|                                     | ICOMP voltage during OLP   | VSENSE = 0 V                               | 2.7    | 3      | 3.3    | V                 |
| <b>VOLTAGE LOOP</b>                 |  |  |        |        |        |                   |
| V <sub>REF</sub>                    | Reference voltage  | T <sub>A</sub> = 25°C                      | 4.93   | 5      | 5.07   | V                 |
|                                     |  | –40°C ≤ T <sub>A</sub> ≤ +125°C            | 4.87   | 5      | 5.15   | V                 |
| g <sub>mv</sub>                     | Transconductance gain without EDR  |  | –40    | –56    | –70    | µS                |
| g <sub>mv-EDR</sub>                 | Transconductance gain under EDR  |  | –230   | –280   | –340   | µS                |
|                                     | Maximum sink current under normal operation  | VSENSE = 5 V, VCOMP = 4 V                  | 23     | 40     | 57     | µA                |
|                                     | Source current under soft start  | VSENSE = 4 V, VCOMP = 4 V                  | –29    | –40    | –52    | µA                |
|                                     | Maximum current under EDR operation  | VSENSE = 4 V, VCOMP = 2.5 V                | –200   | –275   |        | µA                |

(1) Not production tested. Characterized by design

## Electrical Characteristics (continued)

Unless otherwise noted,  $V_{CC}=15V_{dc}$ ,  $0.1\mu F$  from  $V_{CC}$  to  $GND$ ,  $-40^{\circ}C \leq T_J = T_A \leq +125^{\circ}C$ . All voltages are with respect to  $GND$ . Currents are positive into and negative out of the specified terminal.

| PARAMETER                                   | TEST CONDITIONS                                       | MIN  | TYP   | MAX   | UNIT        |
|---|---|------|-------|-------|-------------|
| VSENSE input bias current                   | $V_{SENSE} = 5 V$                                     | 20   | 100   | 250   | nA          |
| VCOMP voltage during OLP                    | $V_{SENSE} = 0.5 V$ , $I_{VCOMP} = 0.5 mA$            | 0    | 0.04  | 0.10  | V           |
| VCOMP rapid discharge current               | $V_{COMP} = 2 V$ , $V_{CC} = \text{floating}$         |      | 0.37  |       | mA          |
| $V_{PRECHARGE}$ VCOMP precharge voltage     | $I_{VCOMP} = -100 \mu A$ , $V_{SENSE} = 4 V$          |      | 1.5   |       | V           |
| $I_{PRECHARGE}$ VCOMP precharge current     | $V_{COMP} = 0 V$                                      |      | -1    |       | mA          |
| VSENSE threshold, end-of-soft-start         | Initial Start-up                                      |      | 98    |       | % $V_{REF}$ |
| <b>GATE DRIVER</b>                          |   |      |       |       |             |
| GATE current, peak, sinking <sup>(1)</sup>  | $C_{GATE} = 4.7 nF$                                   |      | 2     |       | A           |
| GATE current, peak, sourcing <sup>(1)</sup> | $C_{GATE} = 4.7 nF$                                   |      | -1.5  |       | A           |
| GATE rise time                              | $C_{GATE} = 4.7 nF$ , GATE = 2 V to 8 V               | 8    | 40    | 60    | ns          |
| GATE fall time                              | $C_{GATE} = 4.7 nF$ , GATE = 8 V to 2 V               | 8    | 25    | 40    | ns          |
| GATE low voltage, no load                   | $I_{GATE} = 0 A$                                      |      | 0     | 0.01  | V           |
| GATE low voltage, sinking                   | $I_{GATE} = 20 mA$                                    |      | 0.04  | 0.06  | V           |
| GATE low voltage, sourcing                  | $I_{GATE} = -20 mA$                                   |      | -0.04 | -0.06 | V           |
| GATE low voltage, sinking, OFF              | $V_{CC} = 5 V$ , $I_{GATE} = 5 mA$                    | 0.1  | 0.2   | 0.31  | V           |
| GATE low voltage, sinking, OFF              | $V_{CC} = 5 V$ , $I_{GATE} = 20 mA$                   | 0.4  | 0.8   | 1.4   | V           |
| GATE high voltage                           | $V_{CC} = 20 V$ , $C_{GATE} = 4.7 nF$                 | 14.5 | 15.2  | 16.1  | V           |
| GATE high voltage                           | $V_{CC} = 12.2 V$ , $C_{GATE} = 4.7 nF$               | 10.8 | 11.2  | 12    | V           |
| GATE high voltage                           | $V_{CC} = V_{CCOFF} + 0.2 V$ ,<br>$C_{GATE} = 4.7 nF$ | 8.2  | 9     | 10.1  | V           |



**SKYTECH**  
ELECTRONIC

## 7.6 Typical Characteristics

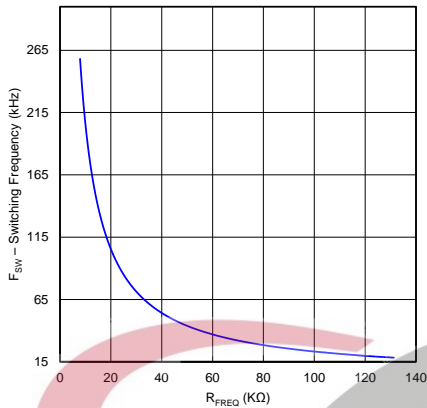
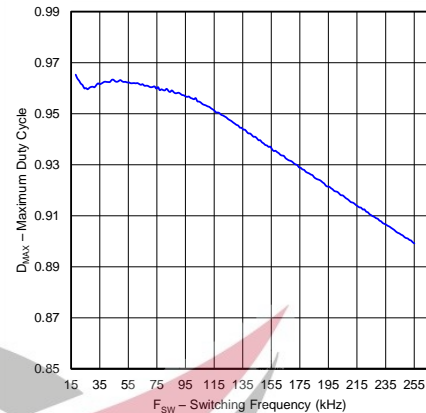

Figure 1. Switching Frequency vs. Resistor



V<sub>CC</sub> = 15 V

Figure 2. Maximum Duty Cycle vs. Switching Frequency

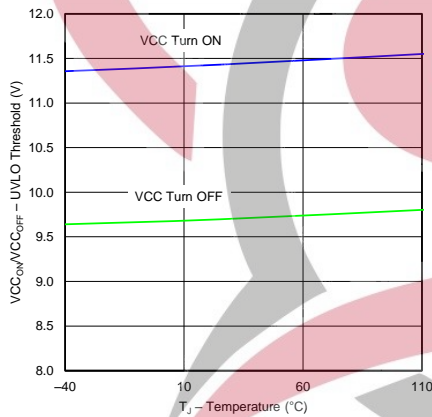
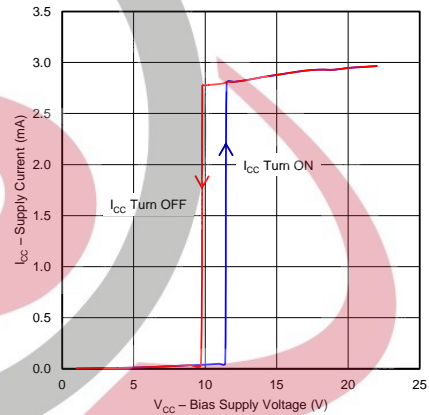

Figure 3. UVLO Threshold vs. Temperature



T<sub>J</sub> = 25 °C  
No Gate Load

V<sub>SENSE</sub> = 3 V  
F<sub>SW</sub> = 65 kHz

Figure 4. Supply Current vs. Bias Supply Voltage

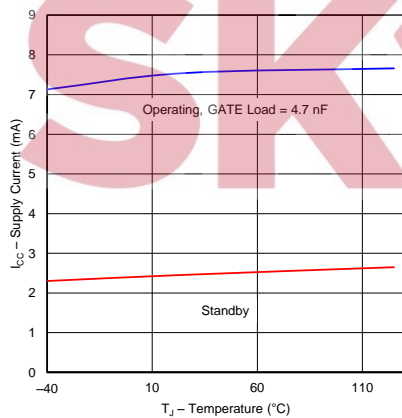

V<sub>CC</sub> = 15 V

Figure 5. Supply Current vs. Temperature

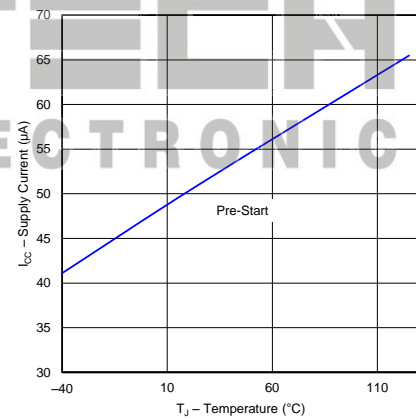

V<sub>CC</sub> = V<sub>CCON</sub> - 0.2 V

Figure 6. Pre-Start Supply Current vs. Temperature



Typical Characteristics (continued)

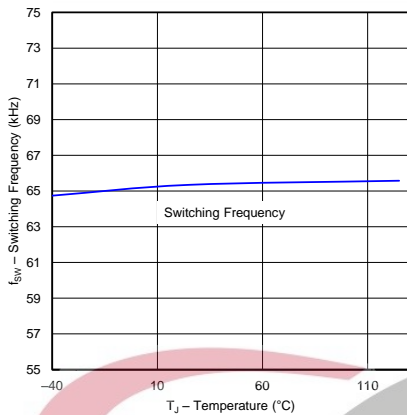

VCC = 15 V F<sub>SW</sub> = 65 kHz

Figure 7. Oscillator Frequency (65 kHz) vs. Temperature

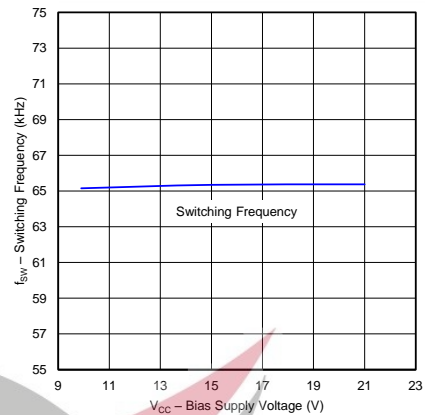

T<sub>J</sub> = 25 °C F<sub>SW</sub> = 65 kHz

Figure 8. Oscillator Frequency (65 kHz) vs. Bias Supply Voltage

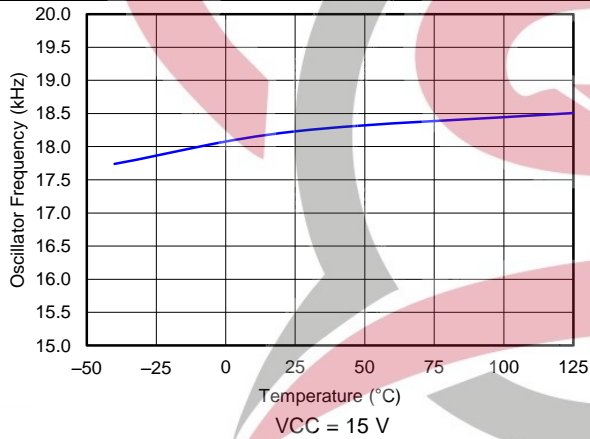

VCC = 15 V

Figure 9. Oscillator Frequency (18 kHz) vs. Temperature

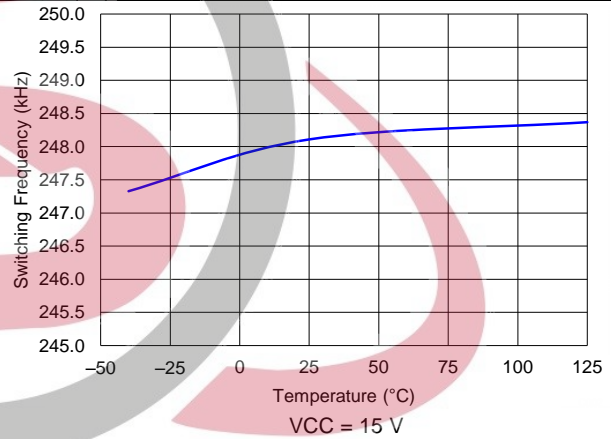

VCC = 15 V

Figure 10. Oscillator Frequency (250 kHz) vs. Temperature

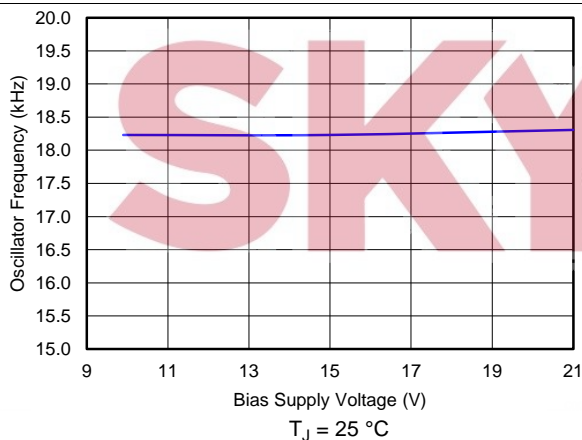

T<sub>J</sub> = 25 °C

Figure 11. Oscillator Frequency (18 kHz) vs. Bias Voltage

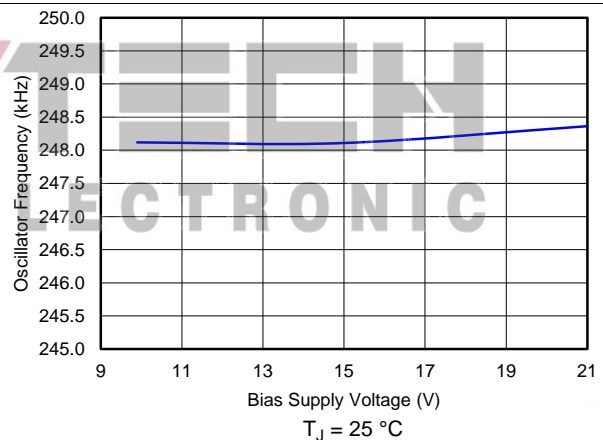

T<sub>J</sub> = 25 °C

Figure 12. Oscillator Frequency (250 kHz) vs. Bias Voltage

Typical Characteristics (continued)

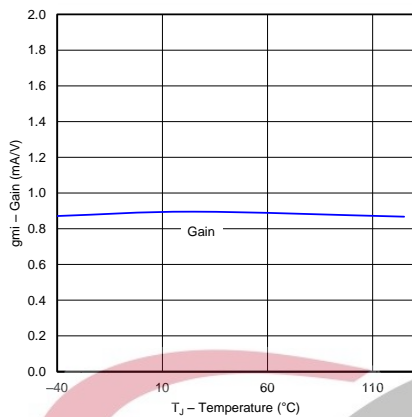

VCC = 15 V

Figure 13. Current Loop Gain vs. Temperature

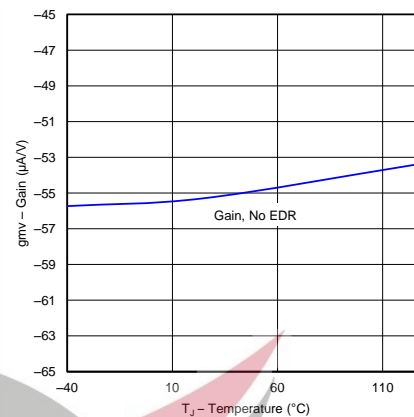

VCC = 15 V

Figure 14. Voltage Loop Gain vs. Temperature

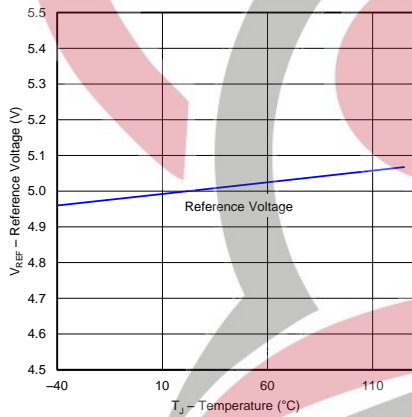

VCC = 15 V

Figure 15. Reference Voltage vs. Temperature

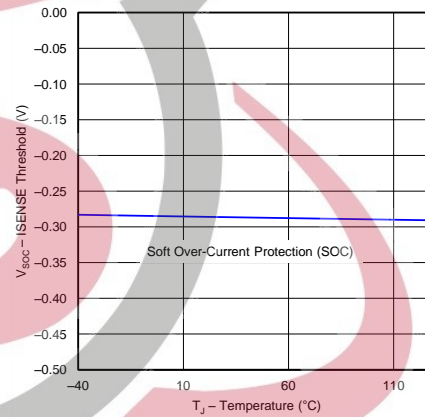

VCC = 15 V

Figure 16. ISENSE Threshold Soft Over Current (SOC) vs. Temperature

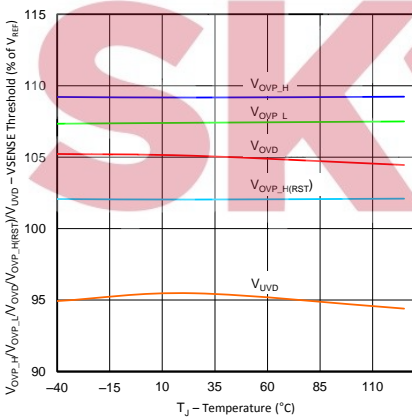

VCC = 15 V

Figure 17. VSENSE Threshold vs. Temperature

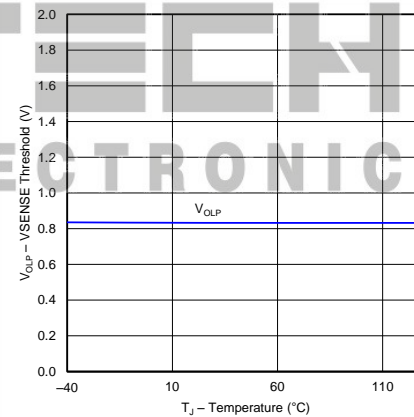

VCC = 15 V

Figure 18. VSENSE Threshold Open Loop vs. Temperature

Typical Characteristics (continued)

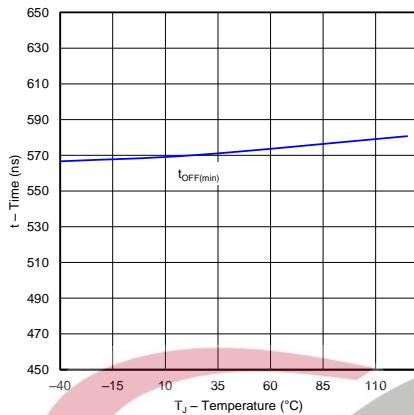

ICOMP = 0.72 V      VSENSE = 3 V      F<sub>SW</sub> = 65 kHz

Figure 19. Minimum Off Time vs. Temperature

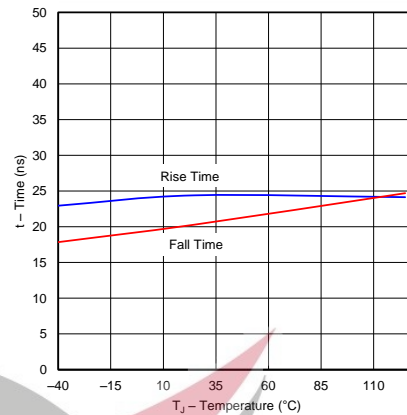

VCC = 15 V      C<sub>GATE</sub> = 4.7 nF      V<sub>GATE</sub> = 2 V-8 V

Figure 20. Gate Drive Rise/Fall Time vs. Temperature

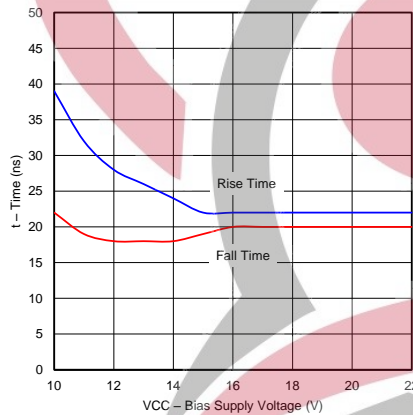

T<sub>J</sub> = 25 °C      C<sub>GATE</sub> = 4.7 nF      V<sub>GATE</sub> = 2 V-8 V

Figure 21. Gate Drive Rise/Fall Time vs. Bias Supply Voltage

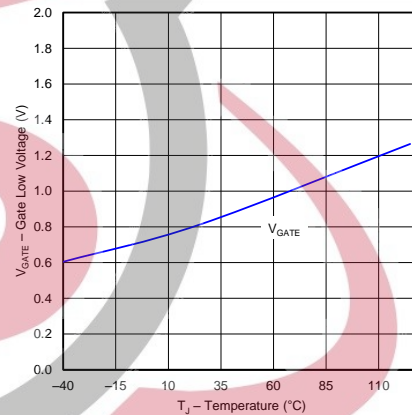

VCC = 15 V      I<sub>GATE</sub> = 20 mA

Figure 22. Gate Low Voltage vs. Temperature



## 8 Detailed Description

### 8.1 Overview

The UCC28180 is a boost controller for power factor correction operating at a fixed frequency in continuous conduction mode. The UCC28180 requires few external components to operate as an active PFC pre-regulator.

UCC28180 employs two control loops. An internal error amplifier and 5-V reference provide a slow outer loop to control output voltage. External compensation of this outer loop is applied by means of the VCOMP pin. The inner current loop shapes the average input current to match the sinusoidal input voltage. The inner current loop avoids the need to sense input voltage by exploiting the relationship between input voltage and boost duty-cycle. External compensation of the inner current loop is applied by means of the ICOMP pin.

The operating switching frequency can be programmed from 18 kHz to 250 kHz simply by connecting the FREQ pin to ground through a resistor.

UCC28180 includes a number of protection functions designed to ensure it is reliable, and will provide safe operation under all conditions, including abnormal or fault conditions.



## 8.2 Functional Block Diagram

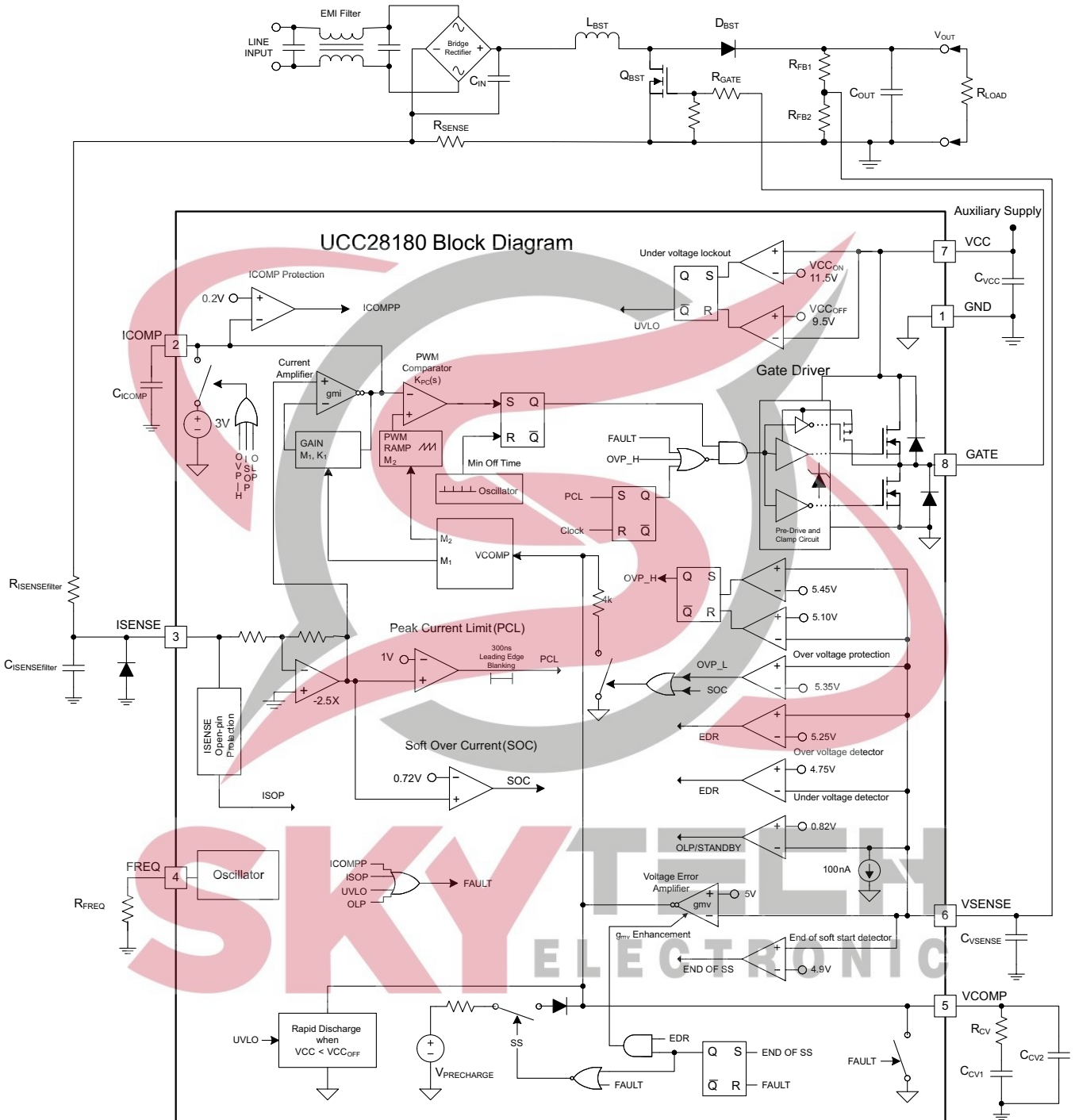

Copyright © 2016, Texas Instruments Incorporated

### 8.3 Feature Description

#### 8.3.1 Soft Start

Soft-Start controls the rate of rise of VCOMP in order to obtain a linear control of the increasing duty cycle as a function of time. VCOMP, the output of the voltage loop transconductance amplifier, is pulled low during UVLO, ICOMP, ISOP and OLP (Open-Loop Protection)/STANDBY. Once the fault condition is released, an initial pre-charge source rapidly charges VCOMP to 1.5 V. After that point, a constant 40  $\mu$ A of current is sourced into the compensation components causing the voltage on this pin to ramp linearly until the output voltage reaches 85% of its final value. At this point, the sourcing current decreases until the output voltage reaches its final rated voltage. The soft-start time is controlled by the voltage error amplifier compensation capacitor values selected, and is user programmable based on desired loop crossover frequency. Once the output voltage exceeds 98% of rated voltage, soft start is over, the initial pre-charge source is disconnected, and EDR is no longer inhibited.

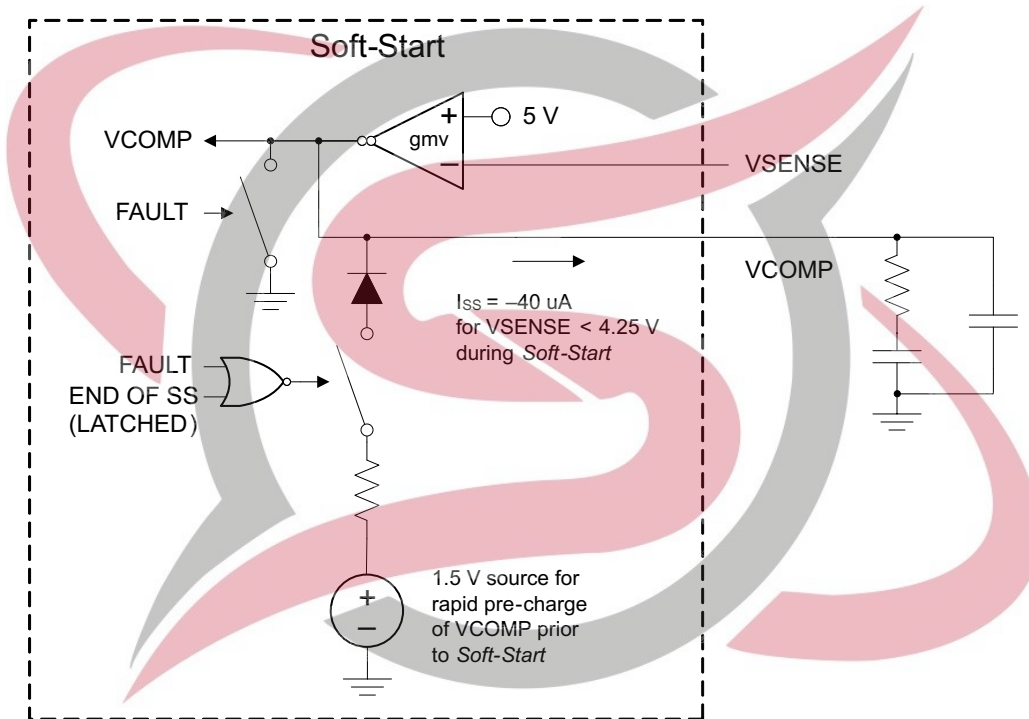

Figure 23. Soft Start

#### 8.3.2 System Protection

System-level protection features help keep the system within safe operating limits.

#### 8.3.3 VCC Undervoltage LockOut (UVLO)

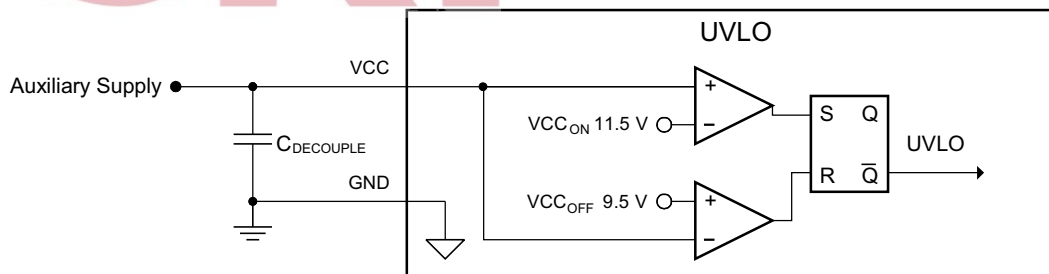

Figure 24. UVLO

## Feature Description (continued)

During startup, Under-Voltage LockOut (UVLO) keeps the device in the off state until VCC rises above the 11.5-V enable threshold,  $V_{CC_{ON}}$ . With a typical 1.7 V of hysteresis on UVLO to increase noise immunity, the device turns off when VCC drops to the 9.5-V disable threshold,  $V_{CC_{OFF}}$ .

If, during a brief AC-line dropout, the VCC voltage falls below the level necessary to bias the internal FAULT circuitry, the UVLO condition enables a special rapid discharge circuit which continues to discharge the VCOMP capacitors through a low impedance despite a complete lack of VCC. This helps to avoid an excessive current surge should the AC-line return while there is still substantial voltage stored on the VCOMP capacitors. Typically, these capacitors can be discharged to less than 1 V within 150 ms of loss of VCC.

### 8.3.4 Output Overvoltage Protection (OVP)

There are two levels of OVP: When VSENSE exceeds 107% ( $V_{OVP\_L}$ ) of the reference voltage, a 4-k $\Omega$  resistor connects VCOMP to ground to rapidly discharge VCOMP. If VSENSE exceeds 109% ( $V_{OVP\_H}$ ) of the reference voltage, GATE output is disabled until VSENSE drops below 102% of the reference voltage.

### 8.3.5 Open Loop Protection/Standby (OLP/Standby)

If the output voltage feedback components were to fail and disconnect (open loop) the signal from the VSENSE input, then it is likely that the voltage error amp would increase the GATE output to maximum duty cycle. To prevent this, an internal pull-down forces VSENSE low. If the output voltage falls below 16.5% of its rated voltage, causing VSENSE to fall below 0.82 V, the device is put in standby, a state where the PWM switching is halted and the device is still on but draws standby current below 2.95 mA. This shutdown feature also gives the designer the option of pulling VSENSE low with an external switch (standby function).

### 8.3.6 ISENSE Open-Pin Protection (ISOP)

If the current feedback components were to fail and disconnect (open loop) the signal to the ISENSE input, then it is likely that the PWM stage would increase the GATE output to maximum duty cycle. To prevent this, an internal pull-up source drives ISENSE above 0.085 V so that a detector forces a state where the PWM switching is halted and the device is still on but draws standby current below 2.95 mA. This shutdown feature avoids continual operation in OVP and severely distorted input current.

### 8.3.7 ICOMP Open-Pin Protection (ICOMPP)

If the ICOMP pin shorts to ground, then the GATE output increases to maximum duty cycle. To prevent this, once ICOMP pin voltage falls below 0.2 V, the PWM switching is halted and the device is still on but draws standby current below 2.95 mA.

### 8.3.8 FAULT Protection

VCC UVLO, OLP/Standby, ISOP and ICOMPP functions constitute the fault protection feature in the UCC28180. Under fault protection, VCOMP pin is pulled low and the device is in standby.

### 8.3.9 Output Overvoltage Detection (OVD), Undervoltage Detection (UVD) and Enhanced Dynamic Response (EDR)

During normal operation, small perturbations on the PFC output voltage rarely exceed  $\pm 5\%$  deviation and the normal voltage control loop gain drives the output back into regulation. For large changes in line or load, if the output voltage perturbation exceeds  $\pm 5\%$ , an output over-voltage (OVD) or under-voltage (UVD) is detected and Enhanced Dynamic Response (EDR) acts to speed up the slow response of the low-bandwidth voltage loop. During EDR, the transconductance of the voltage error amplifier is increased approximately five times to speed charging or discharging the voltage-loop compensation capacitors to the level required for regulation. EDR is disabled when  $5.25\text{ V} > V_{SENSE} > 4.75\text{ V}$ . The EDR feature is not activated until soft start is completed. The UVD is disabled during soft over protection (SOC) condition (since UVD and SOC conflict with each other).

Feature Description (continued)

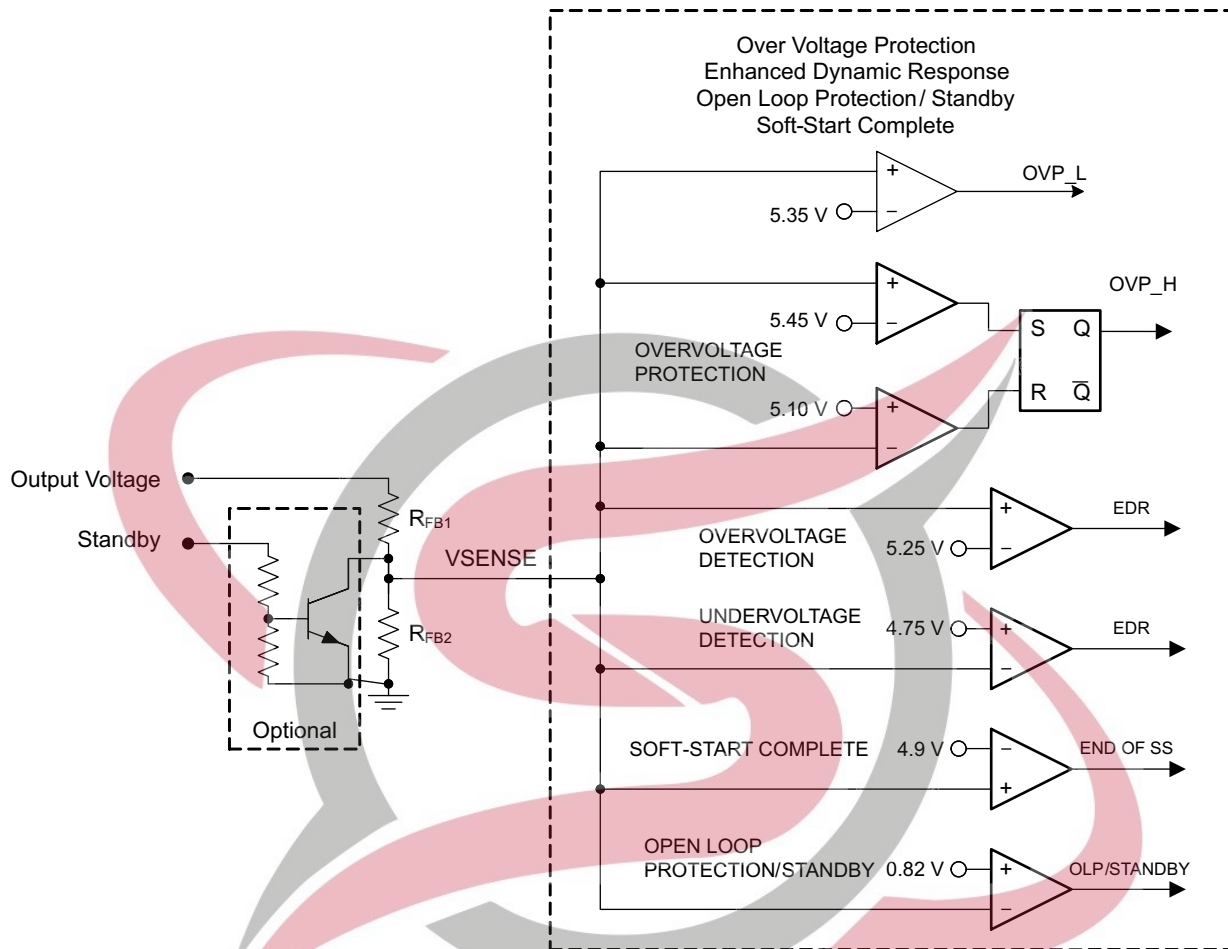

Figure 25. OVP\_H, OVP\_L, EDR, OLP, Soft Start Complete

8.3.10 Overcurrent Protection

Inductor current is sensed by  $R_{ISENSE}$ , a low value resistor in the return path of input rectifier. The other side of the resistor is tied to the system ground. The voltage is sensed on the rectifier side of the sense resistor and is always negative. The voltage at ISENSE is buffered by a fixed gain of -2.5 to provide a positive internal signal to the current functions. There are two overcurrent protection features; Soft Overcurrent (SOC) protects against an overload on the output and Peak Current Limit (PCL) protects against inductor saturation.



Feature Description (continued)

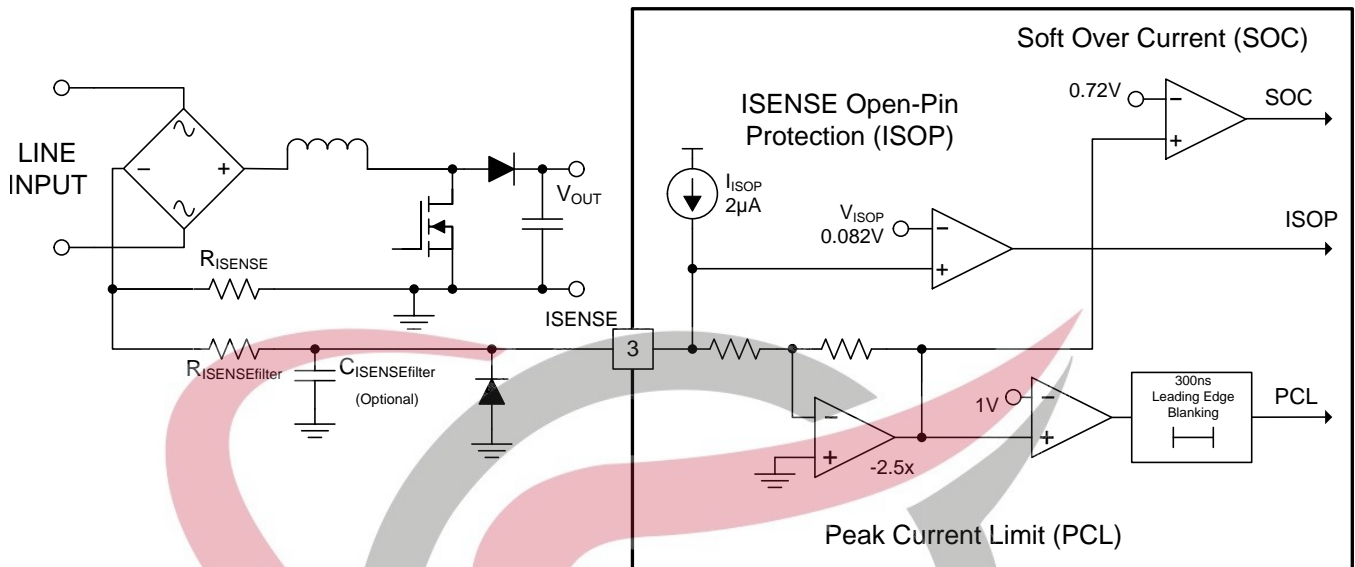

Figure 26. Soft Overcurrent/Peak-Current Limit

8.3.11 Soft Overcurrent (SOC)

Soft Overcurrent (SOC) limits the input current. SOC is activated when the current sense voltage on ISENSE reaches  $-0.285\text{ V}$ . This is a soft control as it does not directly switch off the gate driver. Instead a  $4\text{-k}\Omega$  resistor connects VCOMP to ground to discharge VCOMP and the control loop is adjusted to reduce the PWM duty cycle. The under-voltage detection (UVD) is disabled during SOC.

8.3.12 Peak Current Limit (PCL)

Peak Current Limit (PCL) operates on a cycle-by-cycle basis. When the current sense voltage on ISENSE reaches  $-0.4\text{ V}$ , PCL is activated, immediately terminating the active switch cycle. PCL is leading-edge blanked to improve noise immunity against false triggering.

8.3.13 Current Sense Resistor,  $R_{ISENSE}$

The current sense resistor,  $R_{ISENSE}$ , is sized using the minimum threshold value of Soft Over Current (SOC),  $V_{SOC(min)}$ . To avoid triggering this threshold during normal operation, resulting in a decreased duty-cycle, the resistor is sized for an overload current of 10% more than the peak inductor current,

$$R_{ISENSE} \leq \frac{V_{SOC(min)}}{1.1 I_{L\_PEAK(max)}} \tag{1}$$

Since  $R_{ISENSE}$  "sees" the average input current, worst-case power dissipation occurs at input low-line when input current is at its maximum. Power dissipated by the sense resistor is given by:

$$P_{RISENSE} = (I_{IN\_RMS(max)})^2 R_{ISENSE} \tag{2}$$

Peak current limit (PCL) protection turns off the output driver when the voltage across the sense resistor reaches the PCL threshold,  $V_{PCL}$ . The absolute maximum peak current,  $I_{PCL}$ , is given by:

$$I_{PCL} = \frac{V_{PCL} / 2.5}{R_{ISENSE}} \tag{3}$$

## Feature Description (continued)

### 8.3.14 ISENSE Pin

The voltage at the ISENSE pin should be limited between 0 V and –1.1 V. Inrush currents at start-up have the potential to drive the ISENSE pin significantly more negative so a diode clamp should be used between ISENSE and GND to prevent the ISENSE pin going more negative than 1.1 V, (see Figure 26). The diode  $V_f$  should be greater than the maximum PCL threshold (–0.438 V) and less than –1.1 V across temperature and component variations.

### 8.3.15 Gate Driver

The GATE output is designed with a current-optimized structure to directly drive large values of total MOSFET/IGBT gate capacitance at high turn-on and turn-off speeds. An internal clamp limits voltage on the MOSFET gate to 15.2 V (typical). When VCC voltage is below the UVLO level, the GATE output is held in the off state. An external gate drive resistor,  $R_{GATE}$ , can be used to limit the rise and fall times and dampen ringing caused by parasitic inductances and capacitances of the gate drive circuit and to reduce EMI. The final value of the resistor depends upon the parasitic elements associated with the layout and other considerations. A 10-k $\Omega$  resistor close to the gate of the MOSFET/IGBT, between the gate and ground, discharges stray gate capacitance and helps protect against inadvertent dv/dt-triggered turn-on.

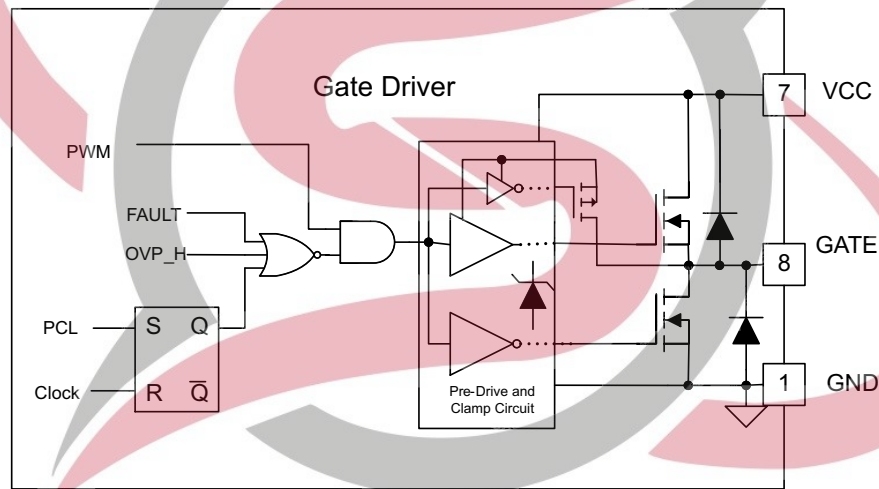

Figure 27. Gate Driver

### 8.3.16 Current Loop

The overall system current loop consists of the current averaging amplifier stage, the pulse width modulator (PWM) stage, the external boost inductor stage and the external current sensing resistor.

### 8.3.17 ISENSE and ICOMP Functions

The negative polarity signal from the current sense resistor is buffered and inverted at the ISENSE input. The internal positive signal is then averaged by the current amplifier ( $g_{mi}$ ), whose output is the ICOMP pin. The voltage on ICOMP is proportional to the average inductor current. An external capacitor to GND is applied to the ICOMP pin for current loop compensation and current ripple filtering. The gain of the averaging amplifier is determined by the internal VCOMP voltage. This gain is non-linear to accommodate the world-wide AC-line voltage range.

ICOMP is connected to 3-V internally whenever OVP\_H, ISOP, or OLP is triggered.

### 8.3.18 Pulse Width Modulator

The PWM stage compares the ICOMP signal with a periodic ramp to generate a leading-edge-modulated output signal which is high whenever the ramp voltage exceeds the ICOMP voltage. The slope of the ramp is defined by a non-linear function of the internal VCOMP voltage.

## Feature Description (continued)

The PWM output signal always starts low at the beginning of the cycle, triggered by the internal clock. The output stays low for a minimum off-time,  $t_{OFF\_min}$ , after which the ramp rises linearly to intersect the ICOMP voltage. The ramp-ICOMP intersection determines  $t_{OFF}$ , and hence  $D_{OFF}$ . Since  $D_{OFF} = V_{IN}/V_{OUT}$  by the boost-topology equation, and since  $V_{IN}$  is sinusoidal in wave-shape, and since ICOMP is proportional to the inductor current, it follows that the control loop forces the inductor current to follow the input voltage wave-shape to maintain boost regulation. Therefore, the average input current is also sinusoidal in wave-shape.

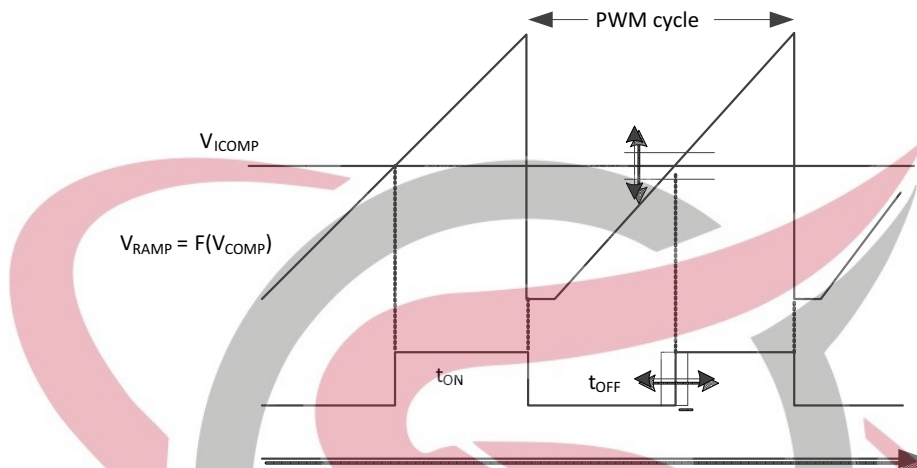

Figure 28. PWM Generation

### 8.3.19 Control Logic

The output of the PWM comparator stage is conveyed to the GATE drive stage, subject to control by various protection functions incorporated into the device. The GATE output duty-cycle may be as high as 98%, but always has a minimum off-time  $t_{OFF\_min}$ . Normal duty-cycle operation can be interrupted directly by OVP\_H and PCL. UVLO, ISOP, ICOMP and OLP/Standby also terminate the GATE output pulse, and further inhibit output until the SS operation can begin.

### 8.3.20 Voltage Loop

The outer control loop of the PFC controller is the voltage loop. This loop consists of the PFC output sensing stage, the voltage error amplifier stage, and the non-linear gain generation.

### 8.3.21 Output Sensing

A resistor-divider network from the PFC output voltage to GND forms the sensing block for the voltage control loop. The resistor ratio is determined by the desired output voltage and the internal 5-V regulation reference voltage.

The very low bias current at the VSENSE input allows the choice of the highest practicable resistor values for lowest power dissipation and standby current. A small capacitor from VSENSE to GND serves to filter the signal in a high-noise environment. This filter time constant should generally be less than 100  $\mu$ s.

### 8.3.22 Voltage Error Amplifier

The transconductance error amplifier ( $g_{mv}$ ) generates an output current proportional to the difference between the voltage feedback signal at VSENSE and the internal 5-V reference. This output current charges or discharges the compensation network capacitors on the VCOMP pin to establish the proper VCOMP voltage for the system operating conditions. Proper selection of the compensation network components leads to a stable PFC pre-regulator over the entire AC-line range and 0% to 100% load range. The total capacitance also determines the rate-of-rise of the VCOMP voltage at *Soft Start*, as discussed earlier.

## Feature Description (continued)

The amplifier output VCOMP is pulled to GND during any fault or standby condition to discharge the compensation capacitors to an initial zero state. Usually, the large capacitor has a series resistor which delays complete discharge for their respective time constant (which may be several hundred milliseconds). If VCC bias voltage is quickly removed after UVLO, the normal discharge transistor on VCOMP loses drive and the large capacitor could be left with substantial voltage on it, negating the benefit of a subsequent *Soft Start*. The UCC28180 incorporates a parallel discharge path which operates without VCC bias, to further discharge the compensation network after VCC is removed.

If the output voltage perturbations exceed  $\pm 5\%$ , and output over-voltage (OVD) or under-voltage (UVD) is detected, the OVD or UVD function invokes EDR which immediately increases the voltage error amplifier transconductance to about  $280 \mu\text{S}$ . This higher gain facilitates faster charging or discharging the compensation capacitors to the new operating level. When output voltage perturbations greater than  $107\%V_{\text{REF}}$  appear at the VSENSE input, a  $4\text{-k}\Omega$  resistor connects VCOMP to ground to quickly reduce VCOMP voltage. When output voltage perturbations are greater than  $109\%V_{\text{REF}}$ , the GATE output is shut off until VSENSE drops below 102% of regulation.

### 8.3.23 Non-Linear Gain Generation

The voltage at VCOMP is used to set the current amplifier gain and the PWM ramp slope. This voltage is subject to modification by the SOC function, as discussed earlier.

Together the current gain and the PWM slope adjust to the different system operating conditions (set by the AC-line voltage and output load level) as VCOMP changes, to provide a low-distortion, high-power-factor, input-current wave shape following that of the input voltage.

## 8.4 Device Functional Modes

This device has no functional modes.



## 9 Application and Implementation

### NOTE

Information in the following applications sections is not part of the TI component specification, and TI does not warrant its accuracy or completeness. TI's customers are responsible for determining suitability of components for their purposes. Customers should validate and test their design implementation to confirm system functionality.

### 9.1 Application Information

The UCC28180 is a switch-mode controller used in boost converters for power factor correction operating at a fixed frequency in continuous conduction mode. The UCC28180 requires few external components to operate as an active PFC pre-regulator. The operating switching frequency can be programmed from 18 kHz to 250 kHz simply by connecting the **FREQ** pin to ground through a resistor.

The internal 5-V reference voltage provides for accurate output voltage regulation over the typical world-wide 85-VAC to 265-VAC mains input range from zero to full output load. The usable system load ranges from 100 W to few kW.

Regulation is accomplished in two loops. The inner current loop shapes the average input current to match the sinusoidal input voltage under continuous inductor current conditions. Under light-load conditions, depending on the boost inductor value, the inductor current may go discontinuous but still meet Class-A/D requirements of IEC 61000-3-2 despite the higher harmonics. The outer voltage loop regulates the PFC output voltage by generating a voltage on **VCOMP** (dependent upon the line and load conditions) which determines the internal gain parameters for maintaining a low-distortion, steady-state, input-current wave shape.



## 9.2 Typical Application

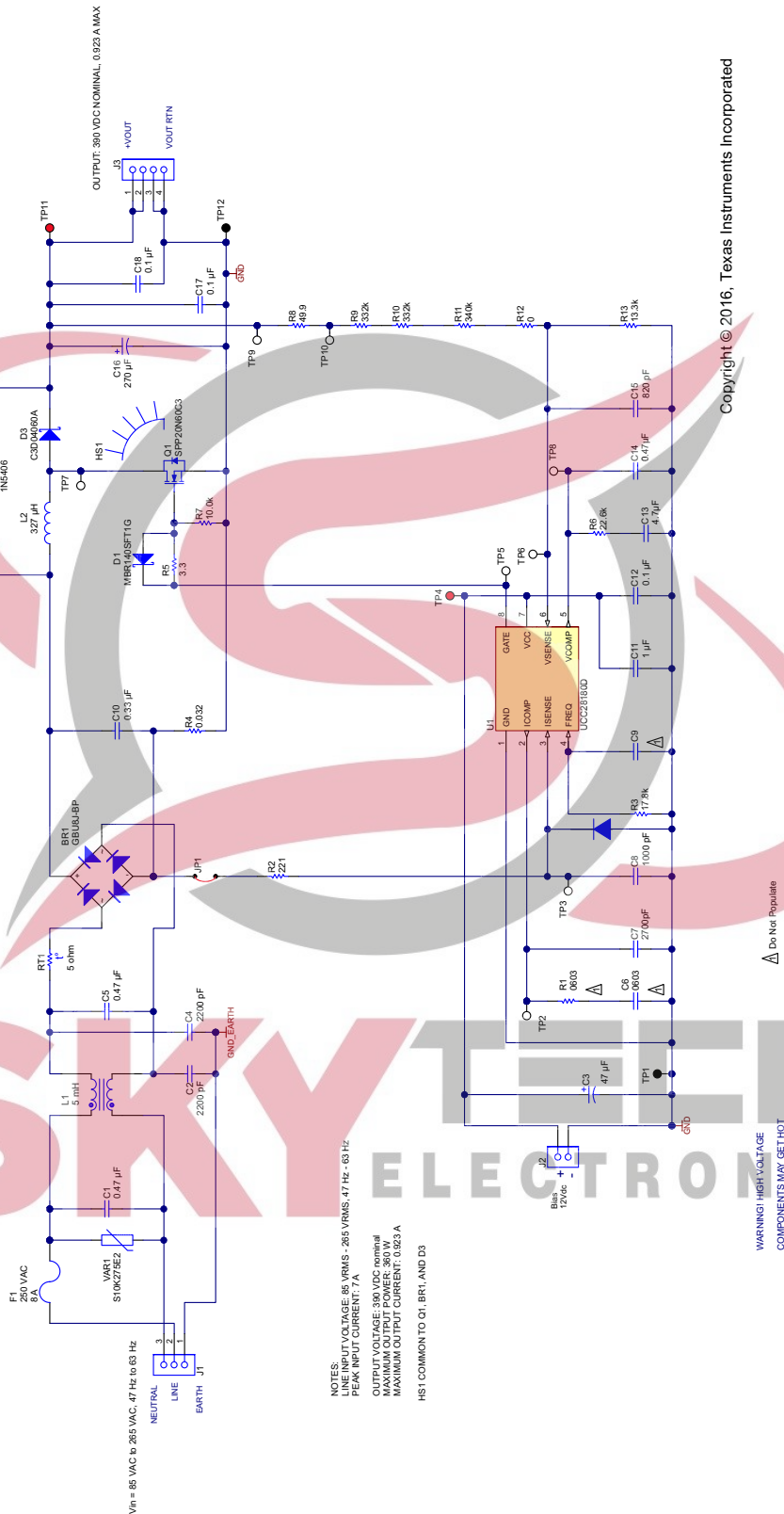

Figure 29. Design Example Schematic

## Typical Application (continued)

### 9.2.1 Design Requirements

This example illustrates the design process and component selection for a continuous mode power factor correction boost converter utilizing the UCC28180. The pertinent design equations are shown for a universal input, 360-W PFC converter with an output voltage of 390 V.

**Table 1. Design Goal Parameters**

| PARAMETER                     |   | TEST CONDITIONS   | MIN | TYP  | MAX   | UNIT      |
|-------------------------------|---|---|-----|------|-------|-----------|
| <b>INPUT CHARACTERISTICS</b>  |   |   |     |      |       |           |
| $V_{IN}$                      | Input voltage                           |   | 85  |      | 265   | $V_{AC}$  |
| $f_{LINE}$                    | Input frequency                         |   | 47  |      | 63    | Hz        |
| $I_{IN(peak)}$                | Peak input current                      | $V_{IN} = V_{IN(min)}$ ,<br>$I_{OUT} = I_{OUT(max)}$  |     | 7    |       | A         |
| <b>OUTPUT CHARACTERISTICS</b> |   |   |     |      |       |           |
| $V_{OUT}$                     | Output voltage                          | $V_{IN(min)} \leq V_{IN} \leq V_{IN(max)}$ ,<br>$f_{LINE(min)} \leq f_{LINE} \leq f_{LINE(max)}$ ,<br>$I_{OUT} \leq I_{OUT(max)}$ | 379 | 390  | 402   | VDC       |
|                               | Line Regulation                         | $V_{IN(min)} \leq V_{IN} \leq V_{IN(max)}$ ,<br>$I_{OUT} = I_{OUT(max)}$  |     |      | 5%    |           |
|                               | Load Regulation                         | $V_{IN} = 115 \text{ VAC}$ ,<br>$f_{LINE} = 60 \text{ Hz}$ ,<br>$I_{OUT(min)} \leq I_{OUT} \leq I_{OUT(max)}$                     |     |      | 5%    |           |
|                               |   | $V_{IN} = 230 \text{ VAC}$ ,<br>$f_{LINE} = 60 \text{ Hz}$ ,<br>$I_{OUT(min)} \leq I_{OUT} \leq I_{OUT(max)}$                     |     |      | 5%    |           |
| $I_{OUT}$                     | Output Load Current                     | $V_{IN(min)} \leq V_{IN} \leq V_{IN(max)}$ ,<br>$f_{LINE(min)} \leq f_{LINE} \leq f_{LINE(max)}$                                  | 0   |      | 0.923 | A         |
| $P_{OUT}$                     | Output Power                            | $V_{IN(min)} \leq V_{IN} \leq V_{IN(max)}$ ,<br>$f_{LINE(min)} \leq f_{LINE} \leq f_{LINE(max)}$                                  | 0   |      | 360   | W         |
| $V_{RIPPLE(SW)}$              | High frequency<br>Output voltage ripple | $V_{IN} = 115 \text{ VAC}$ ,<br>$f_{LINE} = 60 \text{ Hz}$ ,<br>$I_{OUT} = I_{OUT(max)}$  |     | 2.5  | 3.9   | $V_{P-P}$ |
|                               |   | $V_{IN} = 230 \text{ VAC}$ ,<br>$f_{LINE} = 50 \text{ Hz}$ ,<br>$I_{OUT} = I_{OUT(max)}$  |     | 2.5  | 3.9   |           |
| $V_{RIPPLE(f_{LINE})}$        | Line frequency<br>Output voltage ripple | $V_{IN} = 115 \text{ VAC}$ ,<br>$f_{LINE} = 60 \text{ Hz}$ ,<br>$I_{OUT} = I_{OUT(max)}$  |     | 11.6 | 19.5  | $V_{P-P}$ |
|                               |   | $V_{IN} = 230 \text{ VAC}$ ,<br>$f_{LINE} = 50 \text{ Hz}$ ,<br>$I_{OUT} = I_{OUT(max)}$  |     | 13.3 | 19.5  |           |
| $V_{OUT(OVP)}$                | Output overvoltage<br>protection        |   |     | 425  |       | V         |
| $V_{OUT(UVP)}$                | Output undervoltage<br>protection       |   |     | 370  |       |           |

Typical Application (continued)

Table 1. Design Goal Parameters (continued)

| PARAMETER                           |                           | TEST CONDITIONS  | MIN | TYP  | MAX | UNIT |
|-------------------------------------|---------------------------|--|-----|------|-----|------|
| <b>CONTROL LOOP CHARACTERISTICS</b> |                           |  |     |      |     |      |
| f <sub>SW</sub>                     | Switching frequency       | T <sub>J</sub> = 25°C  | 114 | 120  | 126 | kHz  |
| f <sub>(CO)</sub>                   | Voltage Loop Bandwidth    | V <sub>IN</sub> = 162 VDC,<br>I <sub>OUT</sub> = 0.466 A   |     | 8    |     | Hz   |
|                                     | Voltage Loop Phase Margin | V <sub>IN</sub> = 162 VDC,<br>I <sub>OUT</sub> = 0.466 A   |     | 68   |     | °    |
| PF                                  | Power Factor              | V <sub>IN</sub> = 115 VAC,<br>I <sub>OUT</sub> = I <sub>OUT(max)</sub>                               |     | 0.99 |     |      |
| THD                                 | Total harmonic distortion | V <sub>IN</sub> = 115 VAC,<br>f <sub>LINE</sub> = 60 Hz,<br>I <sub>OUT</sub> = I <sub>OUT(max)</sub> |     | 4.3% | 10% |      |
|                                     |                           | V <sub>IN</sub> = 230 VAC,<br>f <sub>LINE</sub> = 50 Hz,<br>I <sub>OUT</sub> = I <sub>OUT(max)</sub> |     | 4%   | 10% |      |
| η                                   | Full load efficiency      | V <sub>IN</sub> = 115 VAC,<br>f <sub>LINE</sub> = 60 Hz,<br>I <sub>OUT</sub> = I <sub>OUT(max)</sub> |     | 94%  |     |      |
|                                     | Ambient temperature       |  |     | 25   |     | °C   |

9.2.2 Detailed Design Procedure

9.2.2.1 Current Calculations

The input fuse, bridge rectifier, and input capacitor are selected based upon the input current calculations. First, determine the maximum average output current, I<sub>OUT(max)</sub>:

$$I_{OUT(max)} = \frac{P_{OUT(max)}}{V_{OUT}} \tag{4}$$

$$I_{OUT(max)} = \frac{360\text{ W}}{390\text{ V}} \cong 0.923\text{ A} \tag{5}$$

The maximum input RMS line current, I<sub>IN\_RMS(max)</sub>, is calculated using the parameters from Table 1 and the efficiency and power factor initial assumptions:

$$I_{IN\_RMS(max)} = \frac{P_{OUT(max)}}{\eta V_{IN(min)} PF} \tag{6}$$

$$I_{IN\_RMS(max)} = \frac{360\text{ W}}{0.94 \times 85\text{ V} \times 0.99} = 4.551\text{ A} \tag{7}$$

Based upon the calculated RMS value, the maximum input current, I<sub>IN(max)</sub>, and the maximum average input current, I<sub>IN\_AVG(max)</sub>, assuming the waveform is sinusoidal, can be determined.

$$I_{IN(max)} = \sqrt{2} I_{IN\_RMS(max)} \tag{8}$$

$$I_{IN(max)} = \sqrt{2} \times 4.551\text{ A} = 6.436\text{ A} \tag{9}$$

$$I_{IN\_AVG(max)} = \frac{2 I_{IN(max)}}{\pi} \tag{10}$$

$$I_{IN\_AVG(max)} = \frac{2 \times 6.436\text{ A}}{\pi} = 4.097\text{ A} \tag{11}$$



### 9.2.2.2 Switching Frequency

The UCC28180 switching frequency is user programmable with a single resistor on the FREQ pin to ground. For this design, the switching frequency,  $f_{SW}$ , was chosen to be 120 kHz. Figure 30 (same as Figure 1) could be used to select the suitable resistor to program the switching frequency or the value can be calculated using constant scaling values of  $f_{TYP}$  and  $R_{TYP}$ . In all cases,  $f_{TYP}$  is a constant that is equal to 65 kHz,  $R_{INT}$  is a constant that is equal to 1 M $\Omega$ , and  $R_{TYP}$  is a constant that is equal to 32.7 k $\Omega$ . Simply applying the calculation below yields the appropriate resistor that should be placed between FREQ and GND:

$$R_{FREQ} = \frac{f_{TYP} \times R_{TYP} \times R_{INT}}{(f_{SW} \times R_{INT}) + (R_{TYP} \times f_{SW}) - (R_{TYP} \times f_{TYP})} \quad (12)$$

$$R_{FREQ} = \frac{65\text{kHz} \times 32.7\text{k}\Omega \times 1\text{M}\Omega}{(120\text{kHz} \times 1\text{M}\Omega) + (32.7\text{k}\Omega \times 120\text{kHz}) - (32.7\text{k}\Omega \times 65\text{kHz})} = 17.451\text{k}\Omega \quad (13)$$

A typical value of 17.8 k $\Omega$  for the FREQ resistor results in a switching frequency of 118 kHz.

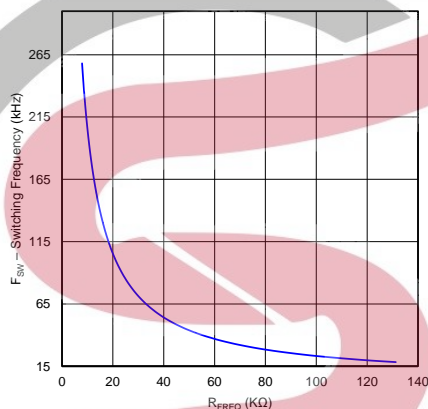

Figure 30. Frequency vs.  $R_{FREQ}$

### 9.2.2.3 Bridge Rectifier

The input bridge rectifier must have an average current capability that exceeds the input average current. Assuming a forward voltage drop,  $V_{F\_BRIDGE}$ , of 1 V across the rectifier diodes, BR1, the power loss in the input bridge,  $P_{BRIDGE}$ , can be calculated:

$$P_{BRIDGE} = 2V_{F\_BRIDGE}I_{IN\_AVG(max)} \quad (14)$$

$$P_{BRIDGE} = 2 \times 1\text{V} \times 4.097\text{A} = 8.195\text{W} \quad (15)$$

Heat sinking will be required to maintain operation within the bridge rectifier's safe operating area.

### 9.2.2.4 Inductor Ripple Current

The UCC28180 is a Continuous Conduction Mode (CCM) controller but if the chosen inductor allows relatively high-ripple current, the converter will be forced to operate in Discontinuous Mode (DCM) at light loads and at the higher input voltage range. High-inductor ripple current has an impact on the CCM/DCM boundary and results in higher light-load THD, and also affects the choices for the input capacitor,  $R_{SENSE}$  and  $C_{ICOMP}$  values. Allowing an inductor ripple current,  $\Delta I_{RIPPLE}$ , of 20% or less will result in CCM operation over the majority of the operating range but requires a boost inductor that has a higher inductance value and the inductor itself will be physically large. As with all converter designs, decisions must be made at the onset in order to optimize performance with size and cost. In this design example, the inductor is sized in such a way as to allow a greater amount of ripple current in order to minimize space with the understanding that the converter operates in DCM at the higher input voltages and at light loads but optimized for a nominal input voltage of 115 V<sub>AC</sub> at full load. Although specifically defined as a CCM controller, the UCC28180 is shown in this application to meet the overall performance goals while transitioning into DCM at high-line voltage, at a higher load level.

### 9.2.2.5 Input Capacitor

The input capacitor must be selected based upon the input ripple current and an acceptable high frequency input voltage ripple. Allowing an inductor ripple current,  $\Delta I_{\text{RIPPLE}}$ , of 40% and a high frequency voltage ripple factor,  $\Delta V_{\text{RIPPLE\_IN}}$ , of 7%, the maximum input capacitor value,  $C_{\text{IN}}$ , is calculated by first determining the input ripple current,  $I_{\text{RIPPLE}}$ , and the input voltage ripple,  $V_{\text{IN\_RIPPLE}}$ :

$$I_{\text{RIPPLE}} = \Delta I_{\text{RIPPLE}} I_{\text{IN(max)}} \quad (16)$$

$$\Delta I_{\text{RIPPLE}} = 0.4 \quad (17)$$

$$I_{\text{RIPPLE}} = 0.4 \times 6.436 \text{ A} = 2.575 \text{ A} \quad (18)$$

$$V_{\text{IN\_RIPPLE}} = \Delta V_{\text{RIPPLE\_IN}} V_{\text{IN\_RECTIFIED(min)}} \quad (19)$$

$$\Delta V_{\text{RIPPLE\_IN}} = 0.07 \quad (20)$$

$$V_{\text{IN\_RECTIFIED}} = \sqrt{2} V_{\text{IN}} \quad (21)$$

$$V_{\text{IN\_RECTIFIED}} = \sqrt{2} \times 85 \text{ V} = 120 \text{ V} \quad (22)$$

$$V_{\text{IN\_RIPPLE}} = 0.07 \times 120 \text{ V} = 8.415 \text{ V} \quad (23)$$

The recommended value for the input x-capacitor can now be calculated:

$$C_{\text{IN}} = \frac{I_{\text{RIPPLE}}}{8f_{\text{SW}} V_{\text{IN\_RIPPLE}}} \quad (24)$$

$$C_{\text{IN}} = \frac{2.575 \text{ A}}{8 \times 118 \text{ kHz} \times 8.415 \text{ V}} = 0.324 \mu\text{F} \quad (25)$$

A standard value 0.33- $\mu\text{F}$  Y2/X2 film capacitor is used.

### 9.2.2.6 Boost Inductor

Based upon the allowable inductor ripple current discussed above, the boost inductor,  $L_{\text{BST}}$ , is selected after determining the maximum inductor peak current,  $I_{\text{L\_PEAK}}$ :

$$I_{\text{L\_PEAK(max)}} = I_{\text{IN(max)}} + \frac{I_{\text{RIPPLE}}}{2} \quad (26)$$

$$I_{\text{L\_PEAK(max)}} = 6.436 \text{ A} + \frac{2.575 \text{ A}}{2} = 7.724 \text{ A} \quad (27)$$

The minimum value of the boost inductor is calculated based upon the acceptable ripple current,  $I_{\text{RIPPLE}}$ , at a worst case duty cycle of 0.5:

$$L_{\text{BST(min)}} \geq \frac{V_{\text{OUT}} D(1-D)}{f_{\text{SW}} I_{\text{RIPPLE}}} \quad (28)$$

$$L_{\text{BST(min)}} \geq \frac{390 \text{ V} \times 0.5(1-0.5)}{118 \text{ kHz} \times 2.575 \text{ A}} \geq 321 \mu\text{H} \quad (29)$$

The recommended minimum value for the boost inductor assuming a 40% ripple current is 321  $\mu\text{H}$ ; the actual value of the boost inductor that will be used is 327  $\mu\text{H}$ . With this actual value used, the actual resultant inductor current ripple will be:

$$L_{\text{BST}} = 327 \mu\text{H} \quad (30)$$

$$I_{\text{RIPPLE(actual)}} = \frac{V_{\text{OUT}} D(1-D)}{f_{\text{SW}} L_{\text{BST}}} \quad (31)$$

$$I_{\text{RIPPLE(actual)}} = \frac{390 \text{ V} \times 0.5(1-0.5)}{118 \text{ kHz} \times 327 \mu\text{H}} = 2.527 \text{ A} \quad (32)$$

$$I_{\text{L\_PEAK(max)}} = 6.436 \text{ A} + \frac{2.527 \text{ A}}{2} = 7.7 \text{ A} \quad (33)$$

The duty cycle is a function of the rectified input voltage and will be continuously changing over the half line cycle. The duty cycle,  $DUTY_{(max)}$ , can be calculated at the peak of the minimum input voltage:

$$DUTY_{(max)} = \frac{V_{OUT} - V_{IN\_RECTIFIED(min)}}{V_{OUT}} \quad (34)$$

$$V_{IN\_RECTIFIED(min)} = \sqrt{2} \times 85 \text{ V} = 120 \text{ V} \quad (35)$$

$$DUTY_{(max)} = \frac{390 \text{ V} - 120 \text{ V}}{390 \text{ V}} = 0.692 \quad (36)$$

### 9.2.2.7 Boost Diode

The diode losses are estimated based upon the forward voltage drop,  $V_F$ , at 125°C and the reverse recovery charge,  $Q_{RR}$ , of the diode. Using a silicon carbide Schottky diode, although more expensive, will essentially eliminate the reverse recovery losses and result in less power dissipation:

$$P_{DIODE} = V_{F\_125^\circ\text{C}} I_{OUT(max)} + 0.5 f_{SW} V_{OUT} Q_{RR} \quad (37)$$

$$V_{F\_125^\circ\text{C}} = 1 \text{ V} \quad (38)$$

$$Q_{RR} = 0 \text{ nC} \quad (39)$$

$$P_{DIODE} = (1 \text{ V} \times 0.923 \text{ A}) + (0.5 \times 119 \text{ kHz} \times 390 \text{ V} \times 0 \text{ nC}) = 0.923 \text{ W} \quad (40)$$

This output diode should have a blocking voltage that exceeds the output over voltage of the converter and be attached to an appropriately sized heat sink.

### 9.2.2.8 Switching Element

The MOSFET/IGBT switch will be driven by a GATE output that is clamped at 15.2 V for VCC bias voltages greater than 15.2 V. An external gate drive resistor is recommended to limit the rise time and to dampen any ringing caused by the parasitic inductances and capacitances of the gate drive circuit; this will also help in meeting any EMI requirements of the converter. The design example uses a 3.3-Ω resistor; the final value of any design is dependent upon the parasitic elements associated with the layout of the design. To facilitate a fast turn off, a standard 40-V, 1-A Schottky diode is placed anti-parallel with the gate drive resistor. A 10-kΩ resistor is placed between the gate of the MOSFET/IGBT and ground to discharge the gate capacitance and protect from inadvertent dv/dt triggered turn-on.

The conduction losses of the switch MOSFET, in this design are estimated using the  $R_{DS(on)}$  at 125°C, found in the device data sheet, and the calculated drain to source RMS current,  $I_{DS\_RMS}$ :

$$P_{COND} = I_{DS\_RMS}^2 R_{DS(on)125^\circ\text{C}} \quad (41)$$

$$R_{DS(on)125^\circ\text{C}} = 0.35 \Omega \quad (42)$$

$$I_{DS\_RMS} = \frac{P_{OUT(max)}}{V_{IN\_RECTIFIED(min)}} \sqrt{2 - \frac{16 V_{IN\_RECTIFIED(min)}}{3\pi V_{OUT}}} \quad (43)$$

$$I_{DS\_RMS} = \frac{360 \text{ W}}{120 \text{ V}} \sqrt{2 - \frac{16 \times 120 \text{ V}}{3\pi \times 390 \text{ V}}} = 3.639 \text{ A} \quad (44)$$

$$P_{COND} = 3.639 \text{ A}^2 \times 0.35 \Omega = 4.636 \text{ W} \quad (45)$$

The switching losses are estimated using the rise time,  $t_r$ , and fall time,  $t_f$ , of the MOSFET gate, and the output capacitance losses.

$$t_r = 5 \text{ ns}$$

$$t_f = 4.5 \text{ ns}$$

$$C_{OSS} = 780 \text{ pF} \quad (46)$$

$$P_{SW} = f_{SW} \left[ 0.5 V_{OUT} I_{IN(max)} (t_r + t_f) + 0.5 C_{OSS} V_{OUT}^2 \right] \quad (47)$$

$$P_{SW} = 118 \text{ kHz} \left[ 0.5 \times 390 \text{ V} \times 6.436 \text{ A} (5 \text{ ns} + 4.5 \text{ ns}) + 0.5 \times 780 \text{ pF} \times 390 \text{ V}^2 \right] = 8.407 \text{ W} \quad (48)$$

Total FET losses

$$P_{\text{COND}} + P_{\text{SW}} = 4.636 \text{ W} + 8.407 \text{ W} = 13.042 \text{ W} \quad (49)$$

The MOSFET requires an appropriately sized heat sink.

### 9.2.2.9 Sense Resistor

To accommodate the gain of the non-linear power limit, the sense resistor,  $R_{\text{SENSE}}$ , is sized such that it triggers the soft over current at 10% higher than the maximum peak inductor current using the minimum soft over current threshold of the ISENSE pin,  $V_{\text{SOC}}$ , of ISENSE equal to 0.265 V.

$$R_{\text{SENSE}} = \frac{V_{\text{SOC}(\text{min})}}{I_{\text{L\_PEAK}(\text{max})} \times 1.1} \quad (50)$$

$$R_{\text{SENSE}} = \frac{0.259 \text{ V}}{7.7 \text{ A} \times 1.1} = 0.032 \Omega \quad (51)$$

The power dissipated across the sense resistor,  $P_{\text{RSENSE}}$ , must be calculated:

$$P_{\text{RSENSE}} = I_{\text{IN\_RMS}(\text{max})}^2 R_{\text{SENSE}} \quad (52)$$

$$P_{\text{RSENSE}} = 4.551 \text{ A}^2 \times 0.032 \Omega = 0.663 \text{ W} \quad (53)$$

The peak current limit, PCL, protection feature is triggered when current through the sense resistor results in the voltage across  $R_{\text{SENSE}}$  to be equal to the  $V_{\text{PCL}}$  threshold. For a worst case analysis, the maximum  $V_{\text{PCL}}$  threshold is used:

$$I_{\text{PCL}} = \frac{V_{\text{PCL}(\text{max})}}{R_{\text{SENSE}}} \quad (54)$$

$$I_{\text{PCL}} = \frac{0.438 \text{ V}}{0.032 \Omega} = 13.688 \text{ A} \quad (55)$$

To protect the device from inrush current, a standard 220- $\Omega$  resistor,  $R_{\text{ISENSE}}$ , is placed in series with the ISENSE pin. A 1000-pF capacitor is placed close to the device to improve noise immunity on the ISENSE pin.

### 9.2.2.10 Output Capacitor

The output capacitor,  $C_{\text{OUT}}$ , is sized to meet holdup requirements of the converter. Assuming the downstream converters require the output of the PFC stage to never fall below 300 V,  $V_{\text{OUT\_HOLDUP}(\text{min})}$ , during one line cycle,  $t_{\text{HOLDUP}} = 1/f_{\text{LINE}(\text{min})}$ , the minimum calculated value for the capacitor is:

$$C_{\text{OUT}(\text{min})} \geq \frac{2P_{\text{OUT}(\text{max})} t_{\text{HOLDUP}}}{V_{\text{OUT}}^2 - V_{\text{OUT\_HOLDUP}(\text{min})}^2} \quad (56)$$

$$C_{\text{OUT}(\text{min})} \geq \frac{2 \times 360 \text{ W} \times 21.28 \text{ ms}}{390 \text{ V}^2 - 300 \text{ V}^2} \geq 247 \mu\text{F} \quad (57)$$

It is advisable to de-rate this capacitor value by 10%; the actual capacitor used is 270  $\mu\text{F}$ .

Verifying that the maximum peak-to-peak output ripple voltage will be less than 5% of the output voltage ensures that the ripple voltage will not trigger the output over-voltage or output under-voltage protection features of the controller. If the output ripple voltage is greater than 5% of the regulated output voltage, a larger output capacitor is required. The maximum peak-to-peak ripple voltage, occurring at twice the line frequency, and the ripple current of the output capacitor is calculated:

$$V_{\text{OUT\_RIPPLE}(\text{pp})} < 0.05 V_{\text{OUT}} \quad (58)$$

$$V_{\text{OUT\_RIPPLE}(\text{pp})} < 0.05 \times 390 \text{ V} = 19.5 \text{ V}_{\text{PP}} \quad (59)$$

$$V_{\text{OUT\_RIPPLE}(\text{pp})} = \frac{I_{\text{OUT}}}{2\pi(2f_{\text{LINE}(\text{min})})C_{\text{OUT}}} \quad (60)$$

$$V_{\text{OUT\_RIPPLE}(\text{pp})} = \frac{0.923 \text{ A}}{2\pi(2 \times 47 \text{ Hz}) \times 270 \mu\text{F}} = 5.789 \text{ V} \quad (61)$$

The required ripple current rating at twice the line frequency is equal to:

$$I_{\text{COUT\_2fline}} = \frac{I_{\text{OUT(max)}}}{\sqrt{2}} \quad (62)$$

$$I_{\text{COUT\_2fline}} = \frac{0.923 \text{ A}}{\sqrt{2}} = 0.653 \text{ A} \quad (63)$$

There is a high frequency ripple current through the output capacitor:

$$I_{\text{COUT\_HF}} = I_{\text{OUT(max)}} \sqrt{\frac{16 V_{\text{OUT}}}{3\pi V_{\text{IN\_RECTIFIED(min)}}} - 1.5} \quad (64)$$

$$I_{\text{COUT\_HF}} = 0.923 \text{ A} \sqrt{\frac{16 \times 390 \text{ V}}{3\pi \times 120 \text{ V}} - 1.5} = 1.848 \text{ A} \quad (65)$$

The total ripple current in the output capacitor is the combination of both and the output capacitor must be selected accordingly:

$$I_{\text{COUT\_RMS(total)}} = \sqrt{I_{\text{COUT\_2fline}}^2 + I_{\text{COUT\_HF}}^2} \quad (66)$$

$$I_{\text{COUT\_RMS(total)}} = \sqrt{0.653 \text{ A}^2 + 1.848 \text{ A}^2} = 1.96 \text{ A} \quad (67)$$

### 9.2.2.11 Output Voltage Set Point

For low power dissipation and minimal contribution to the voltage set point, it is recommended to use 1 M $\Omega$  for the top voltage feedback divider resistor, R<sub>FB1</sub>. Multiple resistors in series are used due to the maximum allowable voltage across each. Using the internal 5-V reference, V<sub>REF</sub>, the bottom divider resistor, R<sub>FB2</sub>, is selected to meet the output voltage design goals.

$$R_{\text{FB2}} = \frac{V_{\text{REF}} R_{\text{FB1}}}{V_{\text{OUT}} - V_{\text{REF}}} \quad (68)$$

$$R_{\text{FB2}} = \frac{5 \text{ V} \times 1 \text{ M}\Omega}{390 \text{ V} - 5 \text{ V}} = 13.04 \text{ k}\Omega \quad (69)$$

A standard value 13-k $\Omega$  resistor for R<sub>FB2</sub> results in a nominal output voltage set point of 391 V.

An output over voltage is detected when the output voltage exceeds its nominal set-point level by 5%, as measured when the voltage at VSENSE is 105% of the reference voltage, V<sub>REF</sub>. At this threshold, the enhanced dynamic response (EDR) is triggered and the non-linear gain to the voltage error amplifier will increase the transconductance to VCOMP and quickly return the output to its normal regulated value. This EDR threshold occurs when the output voltage reaches the V<sub>OUT(ovd)</sub> level:

$$V_{\text{OVD}} = 1.05 V_{\text{REF}} = 1.05 \times 5 \text{ V} = 5.25 \text{ V} \quad (70)$$

$$V_{\text{OUT(ovd)}} = V_{\text{OVD}} \left( \frac{R_{\text{FB1}} + R_{\text{FB2}}}{R_{\text{FB2}}} \right) \quad (71)$$

$$V_{\text{OUT(ovd)}} = 5.25 \text{ V} \times \left( \frac{1 \text{ M}\Omega + 13 \text{ k}\Omega}{13 \text{ k}\Omega} \right) = 410.7 \text{ V} \quad (72)$$

In the event of an extreme output over voltage event, the GATE output will be disabled if the output voltage exceeds its nominal set-point value by 9%. The output voltage, V<sub>OUT(ovp)</sub>, at which this protection feature is triggered is calculated as follows:

$$V_{\text{OUT(ovp)}} = 1.09 \times V_{\text{REF}} \left( \frac{R_{\text{FB1}} + R_{\text{FB2}}}{R_{\text{FB2}}} \right) = 426.4 \text{ V} \quad (73)$$

An output under voltage is detected when the output voltage falls below 5% below its nominal set-point as measured when the voltage at VSENSE is 95% of the reference voltage, V<sub>REF</sub>:

$$V_{\text{UVD}} = 0.95 V_{\text{REF}} = 0.95 \times 5 \text{ V} = 4.75 \text{ V} \quad (74)$$

$$V_{OUT(uvp)} = V_{UVD} \left( \frac{R_{FB1} + R_{FB2}}{R_{FB2}} \right) \tag{75}$$

$$V_{OUT(uvp)} = 4.75 \text{ V} \times \left( \frac{1\text{M}\Omega + 13\text{k}\Omega}{13\text{k}\Omega} \right) = 371.6 \text{ V} \tag{76}$$

A small capacitor on VSENSE must be added to filter out noise. Limit the value of the filter capacitor such that the RC time constant is limited to approximately 10 μs so as not to significantly reduce the control response time to output voltage deviations.

$$C_{VSENSE} = \frac{10\mu\text{s}}{R_{FB2}} = 769\text{pF} \tag{77}$$

The closest standard value of 820 pF was used on VSENSE for a time constant of 10.66 μs.

**9.2.2.12 Loop Compensation**

The current loop is compensated first by determining the product of the internal loop variables, M<sub>1</sub>M<sub>2</sub>, using the internal controller constants K<sub>1</sub> and K<sub>FQ</sub>. Compensation is optimized maximum load and nominal input voltage, 115 V<sub>AC</sub> is used for the nominal line voltage for this design:

$$M_1M_2 = \frac{I_{OUT(max)} V_{OUT}^2 2.5R_{SENSE}K_1}{\eta V_{IN\_RMS}^2 K_{FQ}} \tag{78}$$

$$K_{FQ} = \frac{1}{f_{SW}}$$

$$K_{FQ} = \frac{1}{118\text{kHz}} = 8.475\mu\text{s}$$

$$K_1 = 7 \tag{79}$$

$$M_1M_2 = \frac{0.923 \text{ A} \times 390 \text{ V}^2 \times 2.5 \times 0.032 \Omega \times 7}{0.92 \times 115 \text{ V}^2 \times 8.475 \mu\text{s}} = 0.751 \frac{\text{V}}{\mu\text{s}} \tag{80}$$

The VCOMP operating point is found on the following chart, M<sub>1</sub>M<sub>2</sub> vs. VCOMP. Once the M<sub>1</sub>M<sub>2</sub> result is calculated above, find the resultant VCOMP voltage at that operating point to calculate the individual M<sub>1</sub> and M<sub>2</sub> components.

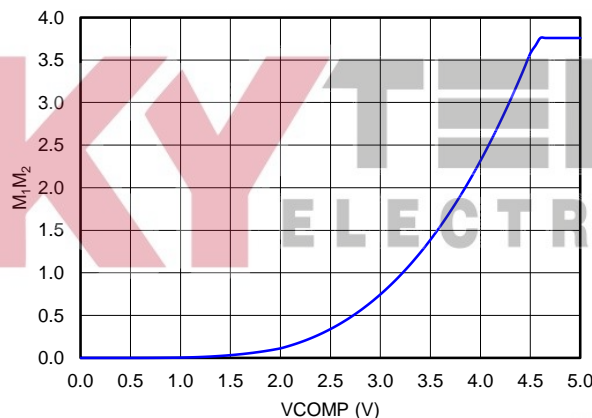

**Figure 31. M1M2 vs. VCOMP**

For the given M<sub>1</sub>M<sub>2</sub> of 0.751 V/μs, the VCOMP approximately equal to 3 V, as shown in Figure 31.

The individual loop factors, M<sub>1</sub> which is the current loop gain factor, and M<sub>2</sub> which is the voltage loop PWM ramp slope, are calculated using the following conditions:

The M<sub>1</sub> non-linear current loop gain factor follows the following identities:

$$M_1 = 0.068 \text{ if } V_{\text{COMP}} < 1 \text{ V} \quad (81)$$

$$M_1 = 0.156 \times V_{\text{COMP}} - 0.088 \text{ if } 1 \text{ V} < V_{\text{COMP}} < 2 \text{ V} \quad (82)$$

$$M_1 = 0.313 \times V_{\text{COMP}} - 0.401 \text{ if } 2 \text{ V} < V_{\text{COMP}} < 4.5 \text{ V} \quad (83)$$

$$M_1 = 1.007 \text{ if } 4.5 \text{ V} < V_{\text{COMP}} < 5 \text{ V} \quad (84)$$

In this example, according to the chart in [Figure 31](#), VCOMP is approximately equal to 3 V, so M1 is calculated to be approximately equal to 0.366:

$$M_1 = 0.313 \times 2.45 - 0.401 = 0.366 \quad (85)$$

The M<sub>2</sub> non-linear PWM ramp slope will obey the following relationships:

$$M_2 = 0 \frac{\text{V}}{\mu\text{s}} \text{ if } V_{\text{COMP}} \leq 0.5 \text{ V} \quad (86)$$

$$M_2 = \frac{f_{\text{SW}}}{65\text{kHz}} \times 0.1223 \times (V_{\text{COMP}} - 0.5)^2 \frac{\text{V}}{\mu\text{s}} \text{ if } 0.5 \text{ V} \leq V_{\text{COMP}} \leq 4.6 \text{ V} \quad (87)$$

$$M_2 = \frac{f_{\text{SW}}}{65\text{kHz}} \times 2.056 \frac{\text{V}}{\mu\text{s}} \text{ if } 4.6 \text{ V} \leq V_{\text{COMP}} \leq 5 \text{ V} \quad (88)$$

In this example, with VCOMP approximately equal to 3 V, M<sub>2</sub> equals 1.388 V/μs:

$$M_2 = \frac{118\text{kHz}}{65\text{kHz}} \times 0.1223 \times (3 - 0.5)^2 \frac{\text{V}}{\mu\text{s}} = 1.388 \frac{\text{V}}{\mu\text{s}} \quad (89)$$

Verify that the product of the individual gain factors, M<sub>1</sub> and M<sub>2</sub>, is approximately equal to the M<sub>1</sub>M<sub>2</sub> factor determined above, if not, iterate the VCOMP value and recalculate M<sub>1</sub>M<sub>2</sub>

$$M_1 \times M_2 = 0.538 \times 1.388 \frac{\text{V}}{\mu\text{s}} = 0.747 \frac{\text{V}}{\mu\text{s}} \quad (90)$$

The product of M<sub>1</sub> and M<sub>2</sub> is within 1% of the M<sub>1</sub>M<sub>2</sub> factor previously calculated:

$$M_1 \times M_2 \cong M_1 M_2 \quad (91)$$

$$0.747 \frac{\text{V}}{\mu\text{s}} \cong 0.751 \frac{\text{V}}{\mu\text{s}} \quad (92)$$

If more accuracy was desired, iteration results in a VCOMP value of 3.004 V where M<sub>1</sub>M<sub>2</sub> and M<sub>1</sub> x M<sub>2</sub> are both equal to 0.751 V/μs.

The non-linear gain variable, M<sub>3</sub>, can now be calculated:

$$M_3 = 0 \text{ if } V_{\text{COMP}} < 5 \text{ V} \quad (93)$$

$$M_3 = \frac{f_{\text{SW}}}{65\text{kHz}} \times \frac{\text{V}}{\mu\text{s}} \times (0.0166 \times V_{\text{COMP}} - 0.0083) \text{ if } 0.5 \text{ V} < V_{\text{COMP}} < 1 \text{ V} \quad (94)$$

$$M_3 = \frac{f_{\text{SW}}}{65\text{kHz}} \times \frac{\text{V}}{\mu\text{s}} \times (0.0572 \times V_{\text{COMP}}^2 - 0.0597 \times V_{\text{COMP}} + 0.0155) \text{ if } 1 \text{ V} < V_{\text{COMP}} < 2 \text{ V} \quad (95)$$

$$M_3 = \frac{f_{\text{SW}}}{65\text{kHz}} \times \frac{\text{V}}{\mu\text{s}} \times (0.1148 \times V_{\text{COMP}}^2 - 0.1746 \times V_{\text{COMP}} + 0.0586) \text{ if } 2 \text{ V} < V_{\text{COMP}} < 4.5 \text{ V} \quad (96)$$

$$M_3 = \frac{f_{\text{SW}}}{65\text{kHz}} \times \frac{\text{V}}{\mu\text{s}} \times (0.1148 \times V_{\text{COMP}}^2 - 0.1746 \times V_{\text{COMP}} + 0.0586) \text{ if } 4.5 \text{ V} < V_{\text{COMP}} < 4.6 \text{ V} \quad (97)$$

$$M_3 = 0 \text{ if } 4.6 \text{ V} < V_{\text{COMP}} < 5 \text{ V} \quad (98)$$

In this example, using 3.004 V for VCOMP for a more precise calculation, M<sub>3</sub> calculates to 1.035 V/μs:

$$M_3 = \frac{118\text{kHz}}{65\text{kHz}} \times \frac{\text{V}}{\mu\text{s}} \times (0.1148 \times 3.004^2 - 0.1746 \times 3.004 + 0.0586) = 1.035 \frac{\text{V}}{\mu\text{s}} \quad (99)$$

For designs that allow a high inductor ripple current, the current averaging pole, which functions to flatten out the ripple current on the input of the PWM comparator, should be at least decade before the converter switching frequency. Analysis on the completed converter may be needed to determine the ideal compensation pole for the current averaging circuit as too large of a capacitor on ICOMP will add phase lag and increase  $i_{THD}$  where as too small of an  $I_{COMP}$  capacitor will result in not enough averaging and an unstable current averaging loop. The frequency of the current averaging pole,  $f_{I_{AVG}}$ , is chosen to be at approximately 5 kHz for this design as the current ripple factor,  $\Delta I_{RIPPLE}$ , was chosen at the onset of the design process to be 40%, which is large enough to force DCM operation and result in relatively high inductor ripple current. The required capacitor on ICOMP,  $C_{I_{COMP}}$ , for this is determined using the transconductance gain,  $g_{mi}$ , of the internal current amplifier:

$$C_{I_{COMP}} = \frac{g_{mi} \times M_1}{K_1 2\pi f_{I_{AVG}}} \tag{100}$$

$$C_{I_{COMP}} = \frac{0.95\text{mS} \times 0.538}{7 \times 2 \times \pi \times 5\text{kHz}} = 2330\text{pF} \tag{101}$$

A standard value 2700-pF capacitor for  $C_{I_{COMP}}$  results in a current averaging pole frequency of 4.314 kHz.

$$f_{I_{AVG}} = \frac{g_{mi} \times M_1}{K_1 \times 2 \times \pi \times 2700\text{pF}} = 4.314\text{kHz} \tag{102}$$

The transfer function of the current loop can be plotted:

$$G_{CL}(f) = \frac{K_1 2.5R_{SENSE} V_{OUT}}{K_{FQ} M_1 M_2 L_{BST}} \times \frac{1}{s(f) + \frac{s(f)^2 K_1 C_{I_{COMP}}}{g_{mi} \times M_1}} \tag{103}$$

$$G_{CLdB}(f) = 20\log(|G_{CL}(f)|) \tag{104}$$

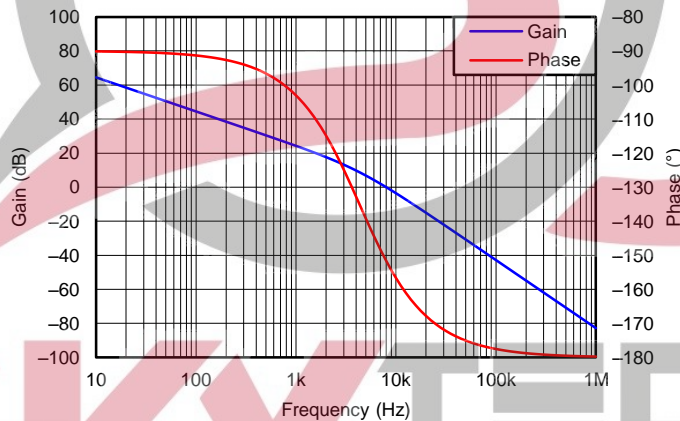

**Figure 32. Bode Plot of the Current Averaging Circuit**

The voltage transfer function,  $G_{VL}(f)$  contains the product of the voltage feedback gain,  $G_{FB}$ , and the gain from the pulse width modulator to the power stage,  $G_{PWM\_PS}$ , which includes the pulse width modulator to power stage pole,  $f_{PWM\_PS}$ . The plotted result is shown in [Figure 32](#).

$$G_{FB} = \frac{R_{FB2}}{R_{FB1} + R_{FB2}} \tag{105}$$

$$G_{FB} = \frac{13\text{k}\Omega}{1\text{M}\Omega + 13\text{k}\Omega} = 0.013$$



$$f_{\text{PWM\_PS}} = \frac{1}{2\pi \frac{K_1 2.5 R_{\text{SENSE}} V_{\text{OUT}}^3 C_{\text{OUT}}}{K_{\text{FQ}} M_1 M_2 V_{\text{IN(nom)}}^2}}$$

$$f_{\text{PWM\_PS}} = \frac{1}{2\pi \frac{7 \times 2.5 \times 0.032 \Omega \times 390 \text{V}^3 \times 270 \mu\text{F}}{8.475 \mu\text{s} \times 0.539 \times 1.392 \frac{\text{V}}{\mu\text{s}} \times 115 \text{V}^2}} = 1.479 \text{Hz} \quad (106)$$

$$G_{\text{PWM\_PS}}(f) = \frac{\frac{M_3 V_{\text{OUT}}}{M_1 M_2 \times 1 \text{V}}}{1 + \frac{s(f)}{2\pi f_{\text{PWM\_PS}}}} \quad (107)$$

$$G_{\text{VL}}(f) = G_{\text{FB}} G_{\text{PWM\_PS}}(f) \quad (108)$$

$$G_{\text{VLdB}}(f) = 20 \log(|G_{\text{VL}}(f)|)$$

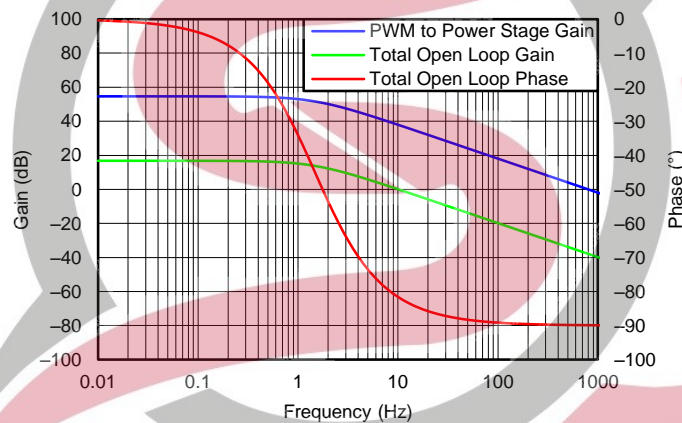

Figure 33. Bode Plot of the Open Voltage Loop without Error Amplifier

The voltage error amplifier is compensated with a zero,  $f_{\text{ZERO}}$ , at the  $f_{\text{PWM\_PS}}$  pole and a pole,  $f_{\text{POLE}}$ , placed at 20 Hz to reject high frequency noise and roll off the gain amplitude. The overall voltage loop crossover,  $f_v$ , is desired to be at 10 Hz. The compensation components of the voltage error amplifier are selected accordingly.

$$f_{\text{ZERO}} = \frac{1}{2\pi R_{\text{VCOMP}} C_{\text{VCOMP}}} \quad (109)$$

$$f_{\text{POLE}} = \frac{1}{2\pi \frac{R_{\text{VCOMP}} C_{\text{VCOMP}} C_{\text{VCOMP\_P}}}{C_{\text{VCOMP}} + C_{\text{VCOMP\_P}}}} \quad (110)$$

$$G_{\text{EA}}(f) = g_{\text{mv}} \left[ \frac{1 + s(f) R_{\text{VCOMP}} C_{\text{VCOMP}}}{(C_{\text{VCOMP}} + C_{\text{VCOMP\_P}}) s(f) \left[ 1 + s(f) \left( \frac{R_{\text{VCOMP}} C_{\text{VCOMP}} C_{\text{VCOMP\_P}}}{C_{\text{VCOMP}} + C_{\text{VCOMP\_P}}} \right) \right]} \right] \quad (111)$$

From Figure 33, the gain of the voltage transfer function at 10 Hz is approximately 0.081 dB. Estimating that the parallel capacitor,  $C_{\text{VCOMP\_P}}$ , is much smaller than the series capacitor,  $C_{\text{VCOMP}}$ , the unity gain will be at  $f_v$ , and the zero will be at  $f_{\text{PWM\_PS}}$ , the series compensation capacitor is determined:

$$f_v = 10 \text{Hz} \quad (112)$$

$$C_{VCOMP} = \frac{g_{mv} \frac{f_V}{f_{PWM\_PS}}}{10^{\frac{0-G_{VLdB}(f)}{20}} \times 2\pi f_V} \tag{113}$$

$$C_{VCOMP} = \frac{56\mu s \times \frac{10Hz}{1.479Hz}}{10^{\frac{0-0.081dB}{20}} \times 2 \times \pi \times 10Hz} = 6.08\mu F \tag{114}$$

The capacitor for VCOMP must have a voltage rating that is greater than the absolute maximum voltage rating of the VCOMP pin, which is 7 V. The readily available standard value capacitor that is rated for at least 10 V in the package size that would fit the application was 4.7 μF and this is the value used for C<sub>VCOMP</sub> in this design example.

R<sub>VCOMP</sub> is calculated using the actual C<sub>VCOMP</sub> capacitor value.

$$C_{VCOMP} = 4.7\mu F \tag{115}$$

$$R_{VCOMP} = \frac{1}{2\pi f_{ZERO} C_{VCOMP}} \tag{116}$$

$$R_{VCOMP} = \frac{1}{2 \times \pi \times 1.479Hz \times 4.7\mu F} = 22.89k\Omega \tag{117}$$

A 22.6-kΩ resistor is used for R<sub>VCOMP</sub>.

$$C_{VCOMP\_P} = \frac{C_{VCOMP}}{2\pi f_{POLE} R_{VCOMP} C_{VCOMP} - 1} \tag{118}$$

$$C_{VCOMP\_P} = \frac{4.7\mu F}{2 \times \pi \times 20Hz \times 22.6k\Omega \times 4.7\mu F - 1} = 0.381\mu F \tag{119}$$

A 0.47-μF capacitor is used for C<sub>VCOMP\_P</sub>.

The total closed loop transfer function, G<sub>VL\_total</sub>, contains the combined stages and is plotted in Figure 34.

$$G_{VL\_total}(f) = G_{FB}(f)G_{PWM\_PS}(f)G_{EA}(f) \tag{120}$$

$$G_{VL\_totaldB}(f) = 20\log(|G_{VL\_total}(f)|) \tag{121}$$

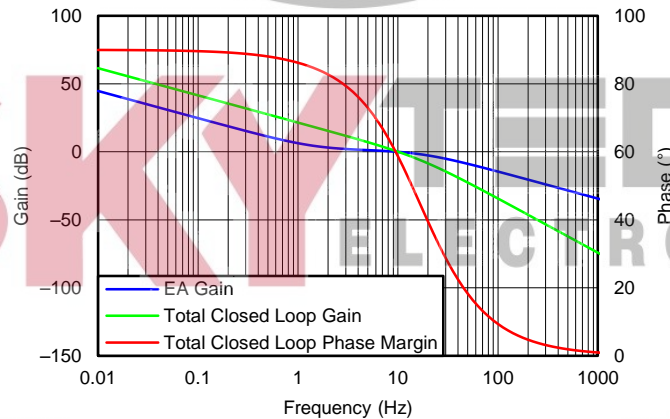

**Figure 34. Closed Loop Voltage Bode Plot**

9.2.3 Application Curve

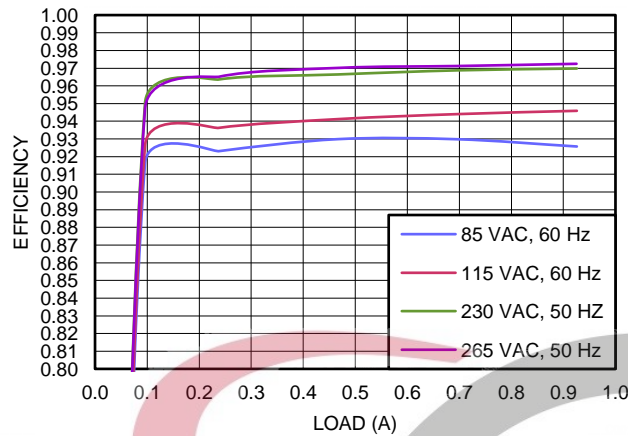

Figure 35. UCC28180EVM-573 Efficiency (As a Function of Line Voltage and Load Current)

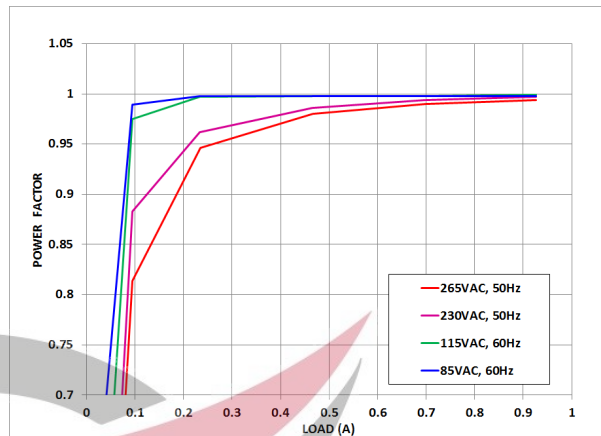

Figure 36. UCC28180EVM-573 Power Factor (As a Function of Line Voltage and Load Current)

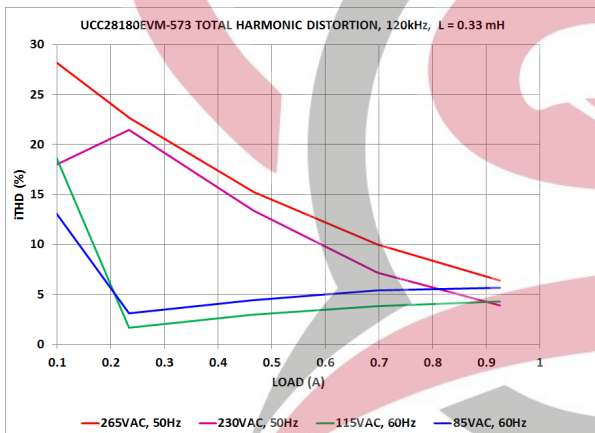

Figure 37. UCC28180EVM-573 Total Harmonic Distortion (As a Function of Line Voltage and Load Current)

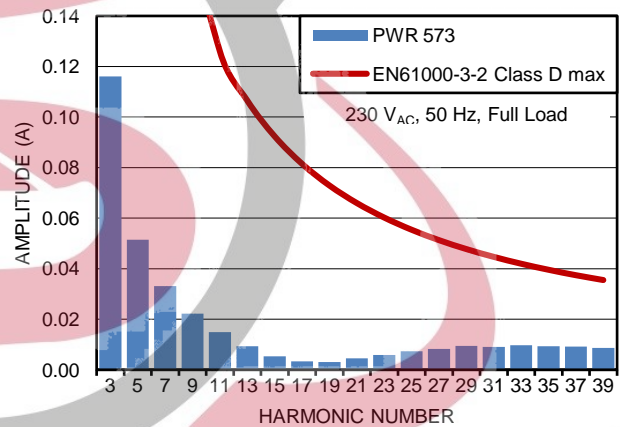

Figure 38. UCC28180EVM-573 Current Harmonics, (230-V<sub>AC</sub>, 50-Hz Input, Full Load, Without the Fundamental)

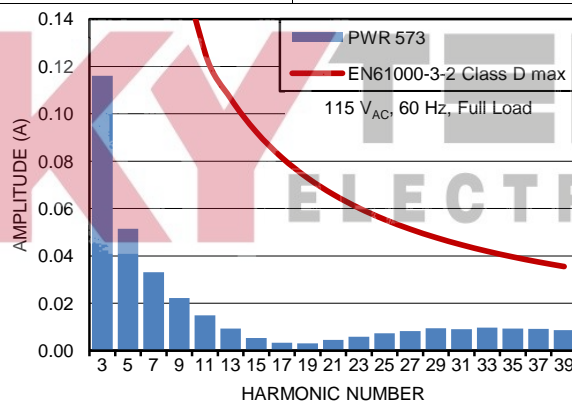

Figure 39. UCC28180EVM-573 Current Harmonics, (115-V<sub>AC</sub>, 60-Hz Input, Full Load, Without the Fundamental)

## 10 Power Supply Recommendations

### 10.1 Bias Supply

The UCC28180 operates from an external bias supply. It is recommended that the device be powered from a regulated auxiliary supply. (This device is not intended to be used from a *bootstrap* bias supply. A *bootstrap* bias supply is fed from the input high voltage through a resistor with sufficient capacitance on VCC to hold up the voltage on VCC until current can be supplied from a bias winding on the boost inductor. For that reason, the minimal hysteresis on VCC would require an unreasonable value of hold-up capacitance.)

During normal operation, when the output is regulated, current drawn by the device includes the nominal run current plus the current supplied to the gate of the external boost switch. Decoupling of the bias supply must take switching current into account in order to keep ripple voltage on VCC to a minimum. A ceramic capacitor of 0.1- $\mu$ F minimum value from VCC to GND with short, wide traces is recommended.

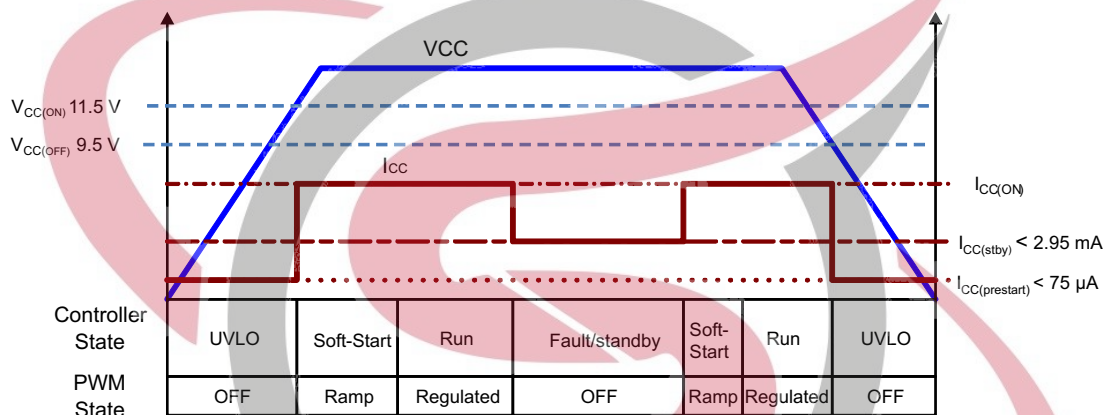

Figure 40. Device Supply States

The device's bias operates in several states. During startup, VCC Under-Voltage LockOut (UVLO) sets the minimum operational DC input voltage of the controller. There are two UVLO thresholds. When the UVLO turn-on threshold is exceeded, the PFC controller turns ON. If the VCC voltage falls below the UVLO turn-off threshold, the PFC controller turns off. During UVLO, current drawn by the device is minimal. After the device turns on, Soft Start (SS) is initiated and the boost inductor current is ramped up in a controlled manner to reduce the stress on the external components and avoids output voltage overshoot. During soft start and after the output is in regulation, the device draws its normal run current. If any of several fault conditions are encountered or if the device is put in standby with an external signal, the device draws a reduced standby current.

## 11 Layout

### 11.1 Layout Guidelines

As with all PWM controllers, the effectiveness of the filter capacitors on the signal pins depends upon the integrity of the ground return. Separating the high di/dt induced noise on the power ground from the low current quiet signal ground is required for adequate noise immunity. Even with a signal layer PCB design, the pin out of the UCC28180 is ideally suited to minimize noise on the small signal traces. As shown in Figure 41, the capacitors on VSENSE, VCOMP, ISENSE, ICOMP, and FREQ (if used) must be all be returned directly to the portion of the ground plane that is the quiet signal GND and not in high-current return path of the converter, shown as power GND. The trace from the FREQ pin to the frequency programming resistor should be as short as possible. It is recommended that the compensation components on ICOMP and VCOMP are located as close as possible to the UCC28180. Placement of these components should take precedence, paying close attention to keeping their traces away from high noise areas. The bypass capacitors on VCC must be located physically close the VCC and GND pins of the UCC28180 but should not be in the immediate path of the signal return.

## Layout Guidelines (continued)

Other layout considerations should include keeping the switch node as short as possible, with a wide trace to reduce induced ringing caused by parasitic inductance. Every effort should be made to avoid noise from the switch node from corrupting the small signal traces with adequate clearance and ground shielding. As some compromises must be made due to limitation of PCB layers or space constraints, traces that must be made long, such as the signal from the current sense resistor shown in [Figure 41](#), should be as wide as possible, avoid long narrow traces.

**Table 2. Layout Component Description for [Figure 41](#)**

| LAYOUT COMPONENTS    |   |
|----------------------|---|
| REFERENCE DESIGNATOR | FUNCTION  |
| U1                   | Controller, UCC28180  |
| Q1                   | Main switch   |
| D2                   | Boost diode   |
| R5                   | RGATE   |
| R7                   | Pull-down resistor on GATE  |
| D1                   | Turn-off diode on GATE  |
| D4                   | ISENSE pin diode  |
| C11, C12             | VCC bypass capacitors   |
| C7                   | ICOMP compensation, C <sub>ICOMP</sub>  |
| R1, C6               | Placeholders for additional ICOMP compensation, if needed                                     |
| C8                   | ISENSE filter, C <sub>ISENSE</sub>  |
| R2                   | ISENSE inrush current limiting resistor, R <sub>ISENSE</sub>                                  |
| R3                   | Frequency programming resistor, R <sub>FREQ</sub>   |
| C9                   | Placeholder for FREQ filter, if needed  |
| R6, C13, C14         | VCOMP compensation components, R <sub>VCOMP</sub> , C <sub>VCOMP_P</sub> , C <sub>VCOMP</sub> |
| C15                  | VSENSE filter, C <sub>VSENSE</sub>  |
| R11, R12             | R <sub>FB1</sub> on VSENSE  |
| R13                  | R <sub>FB2</sub> on VSENSE  |



### 11.2 Layout Example

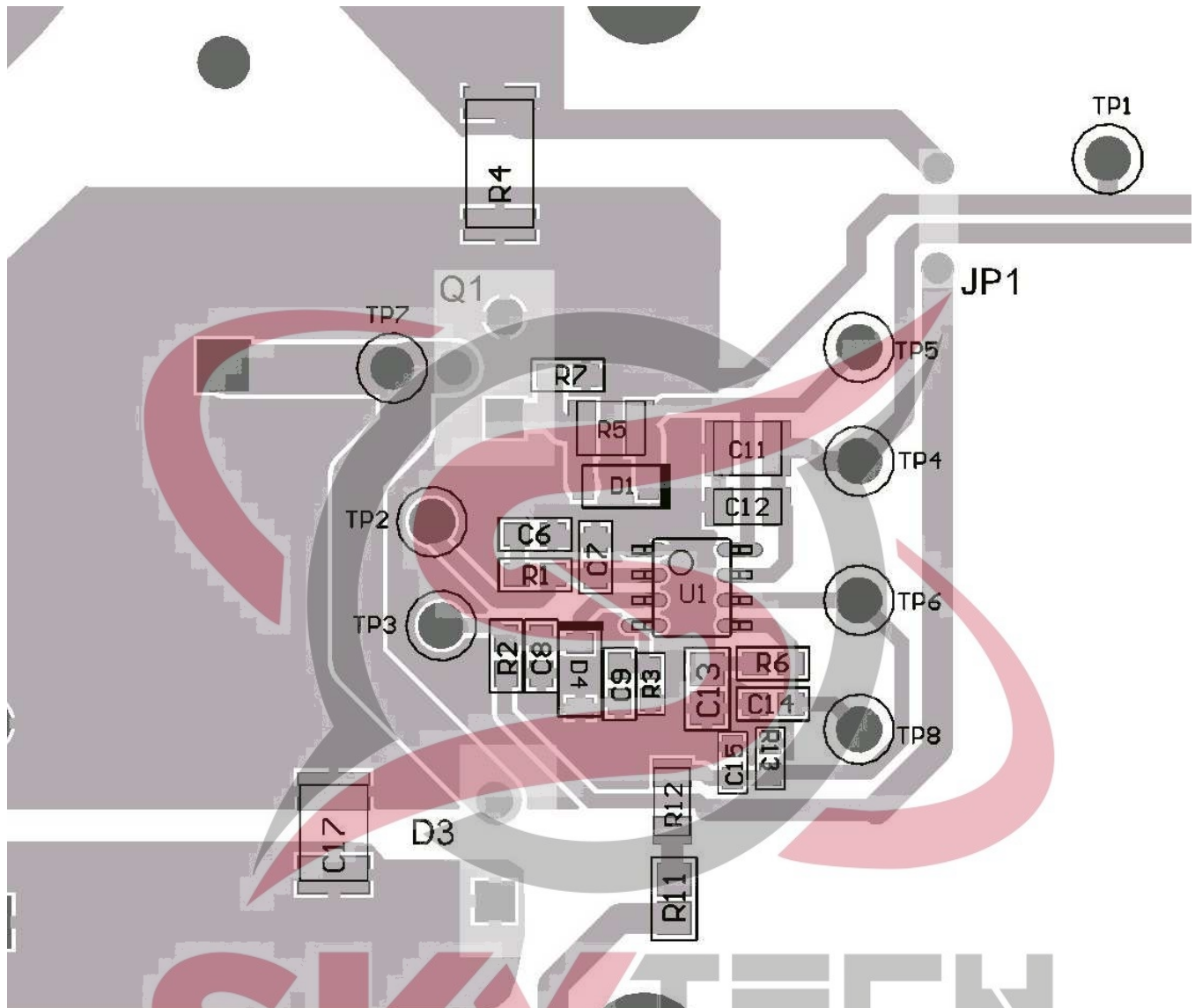

Figure 41. Recommended Layout for UCC28180

## 12 Device and Documentation Support

### 12.1 Documentation Support

#### 12.1.1 Related Documentation

These references, additional design tools, and links to additional references, including design software and models may be found on the web at <http://www.power.ti.com> under Technical Documents.

- User Guide, *Using the UCC28180EVM-573, 360-W Power Factor Correction*, [SLUUAT3](#)
- Design Spreadsheet, *UCC28180 Design Calculator*, [SLUC506](#)

### 12.2 Receiving Notification of Documentation Updates

To receive notification of documentation updates, navigate to the device product folder on ti.com. In the upper right corner, click on *Alert me* to register and receive a weekly digest of any product information that has changed. For change details, review the revision history included in any revised document.

### 12.3 Community Resources

The following links connect to TI community resources. Linked contents are provided "AS IS" by the respective contributors. They do not constitute TI specifications and do not necessarily reflect TI's views; see TI's [Terms of Use](#).

**TI E2E™ Online Community** *TI's Engineer-to-Engineer (E2E) Community*. Created to foster collaboration among engineers. At [e2e.ti.com](http://e2e.ti.com), you can ask questions, share knowledge, explore ideas and help solve problems with fellow engineers.

**Design Support** *TI's Design Support* Quickly find helpful E2E forums along with design support tools and contact information for technical support.

### 12.4 Trademarks

E2E is a trademark of Texas Instruments.  
All other trademarks are the property of their respective owners.

### 12.5 Electrostatic Discharge Caution



These devices have limited built-in ESD protection. The leads should be shorted together or the device placed in conductive foam during storage or handling to prevent electrostatic damage to the MOS gates.

### 12.6 Glossary

[SLYZ022](#) — *TI Glossary*.

This glossary lists and explains terms, acronyms, and definitions.

## 13 Mechanical, Packaging, and Orderable Information

The following pages include mechanical, packaging, and orderable information. This information is the most current data available for the designated devices. This data is subject to change without notice and revision of this document. For browser-based versions of this data sheet, refer to the left-hand navigation.

**PACKAGING INFORMATION**

| Orderable Device | Status<br>(1) | Package Type | Package Drawing | Pins | Package Qty | Eco Plan<br>(2)         | Lead/Ball Finish<br>(6) | MSL Peak Temp<br>(3) | Op Temp (°C) | Device Marking<br>(4/5) | Samples                 |
|------------------|---------------|--------------|-----------------|------|-------------|-------------------------|-------------------------|----------------------|--------------|-------------------------|-------------------------|
| UCC28180D        | ACTIVE        | SOIC         | D               | 8    | 75          | Green (RoHS & no Sb/Br) | NIPDAU                  | Level-1-260C-UNLIM   | -40 to 125   | U28180                  | <a href="#">Samples</a> |
| UCC28180DR       | ACTIVE        | SOIC         | D               | 8    | 2500        | Green (RoHS & no Sb/Br) | NIPDAU                  | Level-1-260C-UNLIM   | -40 to 125   | U28180                  | <a href="#">Samples</a> |

(1) The marketing status values are defined as follows:

**ACTIVE:** Product device recommended for new designs.

**LIFEBUY:** TI has announced that the device will be discontinued, and a lifetime-buy period is in effect.

**NRND:** Not recommended for new designs. Device is in production to support existing customers, but TI does not recommend using this part in a new design.

**PREVIEW:** Device has been announced but is not in production. Samples may or may not be available.

**OBSELETE:** TI has discontinued the production of the device.

(2) **RoHS:** TI defines "RoHS" to mean semiconductor products that are compliant with the current EU RoHS requirements for all 10 RoHS substances, including the requirement that RoHS substance do not exceed 0.1% by weight in homogeneous materials. Where designed to be soldered at high temperatures, "RoHS" products are suitable for use in specified lead-free processes. TI may reference these types of products as "Pb-Free".

**RoHS Exempt:** TI defines "RoHS Exempt" to mean products that contain lead but are compliant with EU RoHS pursuant to a specific EU RoHS exemption.

**Green:** TI defines "Green" to mean the content of Chlorine (Cl) and Bromine (Br) based flame retardants meet JS709B low halogen requirements of <=1000ppm threshold. Antimony trioxide based flame retardants must also meet the <=1000ppm threshold requirement.

(3) MSL, Peak Temp. - The Moisture Sensitivity Level rating according to the JEDEC industry standard classifications, and peak solder temperature.

(4) There may be additional marking, which relates to the logo, the lot trace code information, or the environmental category on the device.

(5) Multiple Device Markings will be inside parentheses. Only one Device Marking contained in parentheses and separated by a "~" will appear on a device. If a line is indented then it is a continuation of the previous line and the two combined represent the entire Device Marking for that device.

(6) Lead/Ball Finish - Orderable Devices may have multiple material finish options. Finish options are separated by a vertical ruled line. Lead/Ball Finish values may wrap to two lines if the finish value exceeds the maximum column width.

**Important Information and Disclaimer:**The information provided on this page represents TI's knowledge and belief as of the date that it is provided. TI bases its knowledge and belief on information provided by third parties, and makes no representation or warranty as to the accuracy of such information. Efforts are underway to better integrate information from third parties. TI has taken and continues to take reasonable steps to provide representative and accurate information but may not have conducted destructive testing or chemical analysis on incoming materials and chemicals. TI and TI suppliers consider certain information to be proprietary, and thus CAS numbers and other limited information may not be available for release.

In no event shall TI's liability arising out of such information exceed the total purchase price of the TI part(s) at issue in this document sold by TI to Customer on an annual basis.





**TAPE AND REEL INFORMATION**

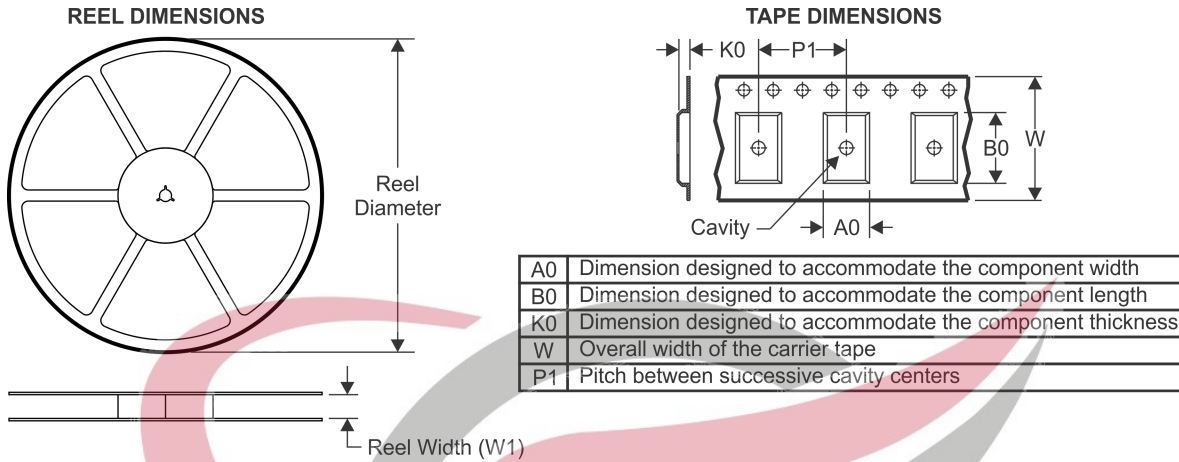

**QUADRANT ASSIGNMENTS FOR PIN 1 ORIENTATION IN TAPE**

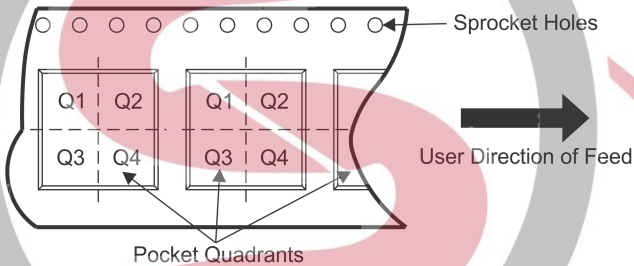

\*All dimensions are nominal

| Device     | Package Type | Package Drawing | Pins | SPQ  | Reel Diameter (mm) | Reel Width W1 (mm) | A0 (mm) | B0 (mm) | K0 (mm) | P1 (mm) | W (mm) | Pin1 Quadrant |
|------------|--------------|-----------------|------|------|--------------------|--------------------|---------|---------|---------|---------|--------|---------------|
| UCC28180DR | SOIC         | D               | 8    | 2500 | 330.0              | 12.4               | 6.4     | 5.2     | 2.1     | 8.0     | 12.0   | Q1            |



**TAPE AND REEL BOX DIMENSIONS**

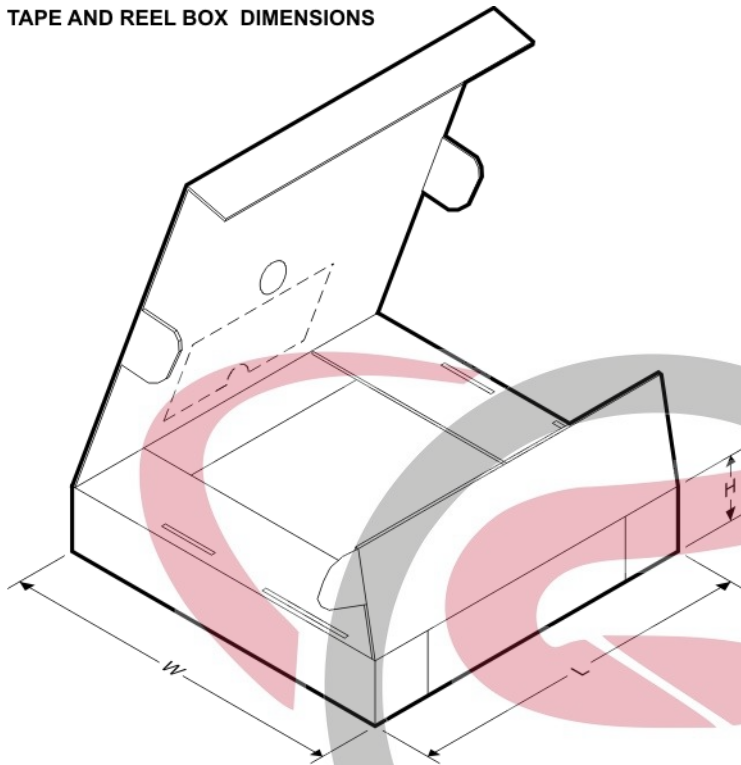

\*All dimensions are nominal

| Device     | Package Type | Package Drawing | Pins | SPQ  | Length (mm) | Width (mm) | Height (mm) |
|------------|--------------|-----------------|------|------|-------------|------------|-------------|
| UCC28180DR | SOIC         | D               | 8    | 2500 | 340.5       | 338.1      | 20.6        |

**SKYTECH**  
ELECTRONIC

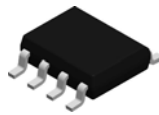

D0008A

PACKAGE OUTLINE

SOIC - 1.75 mm max height

SMALL OUTLINE INTEGRATED CIRCUIT

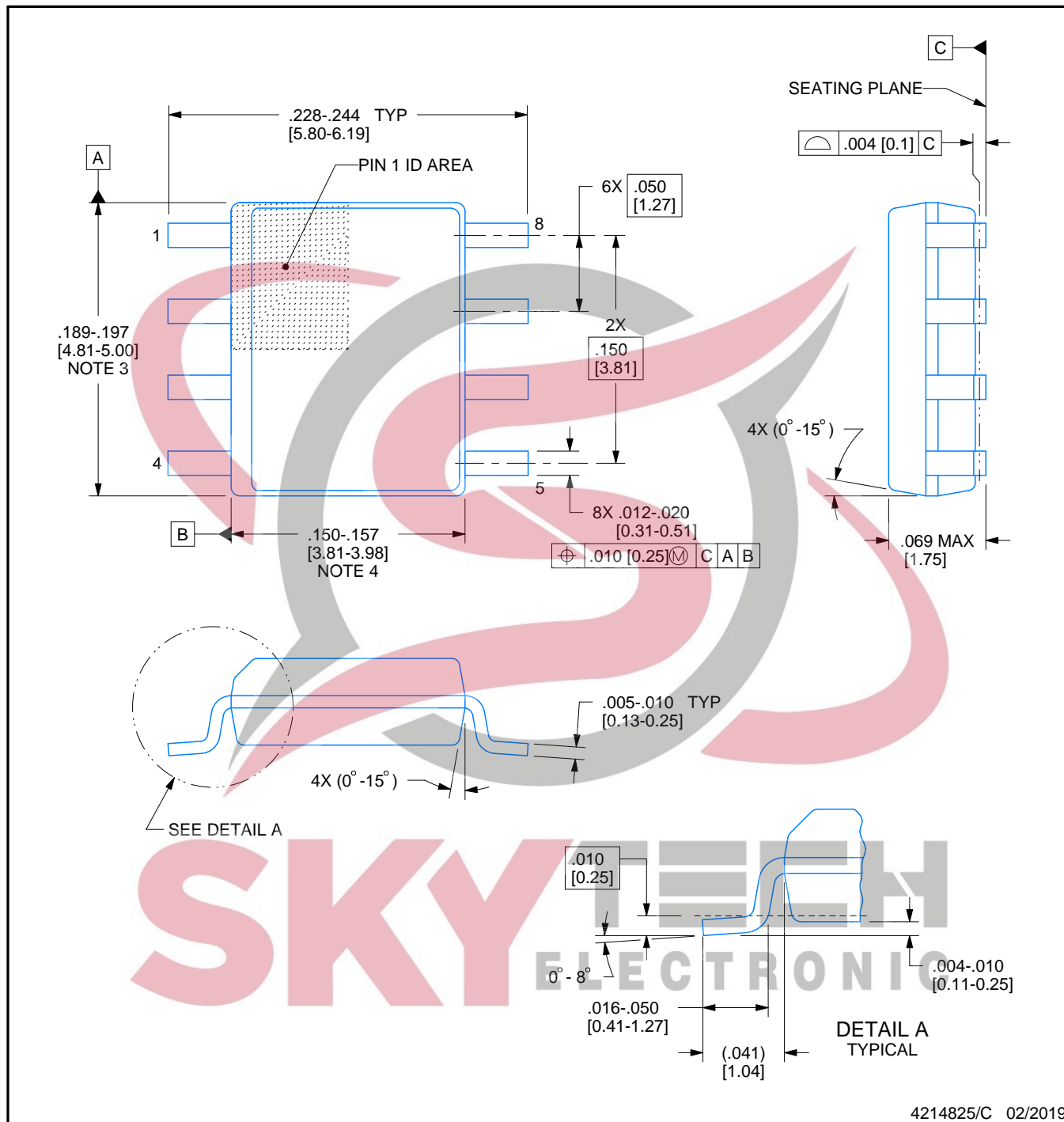

NOTES:

1. Linear dimensions are in inches [millimeters]. Dimensions in parenthesis are for reference only. Controlling dimensions are in inches. Dimensioning and tolerancing per ASME Y14.5M.
2. This drawing is subject to change without notice.
3. This dimension does not include mold flash, protrusions, or gate burrs. Mold flash, protrusions, or gate burrs shall not exceed .006 [0.15] per side.
4. This dimension does not include interlead flash.
5. Reference JEDEC registration MS-012, variation AA.

# EXAMPLE BOARD LAYOUT

D0008A

SOIC - 1.75 mm max height

SMALL OUTLINE INTEGRATED CIRCUIT

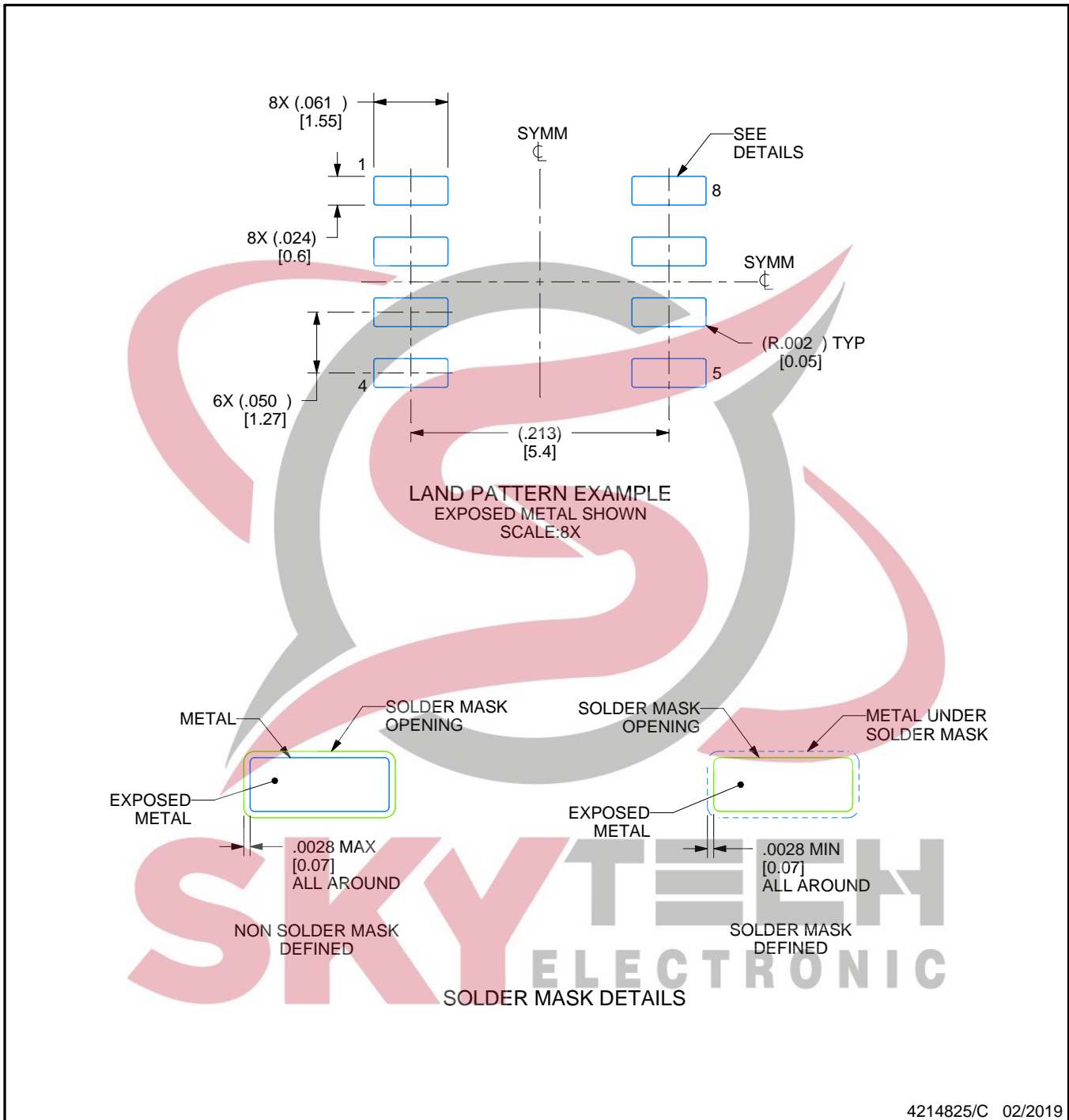

NOTES: (continued)

- 6. Publication IPC-7351 may have alternate designs.
- 7. Solder mask tolerances between and around signal pads can vary based on board fabrication site.

# EXAMPLE STENCIL DESIGN

D0008A

SOIC - 1.75 mm max height

SMALL OUTLINE INTEGRATED CIRCUIT

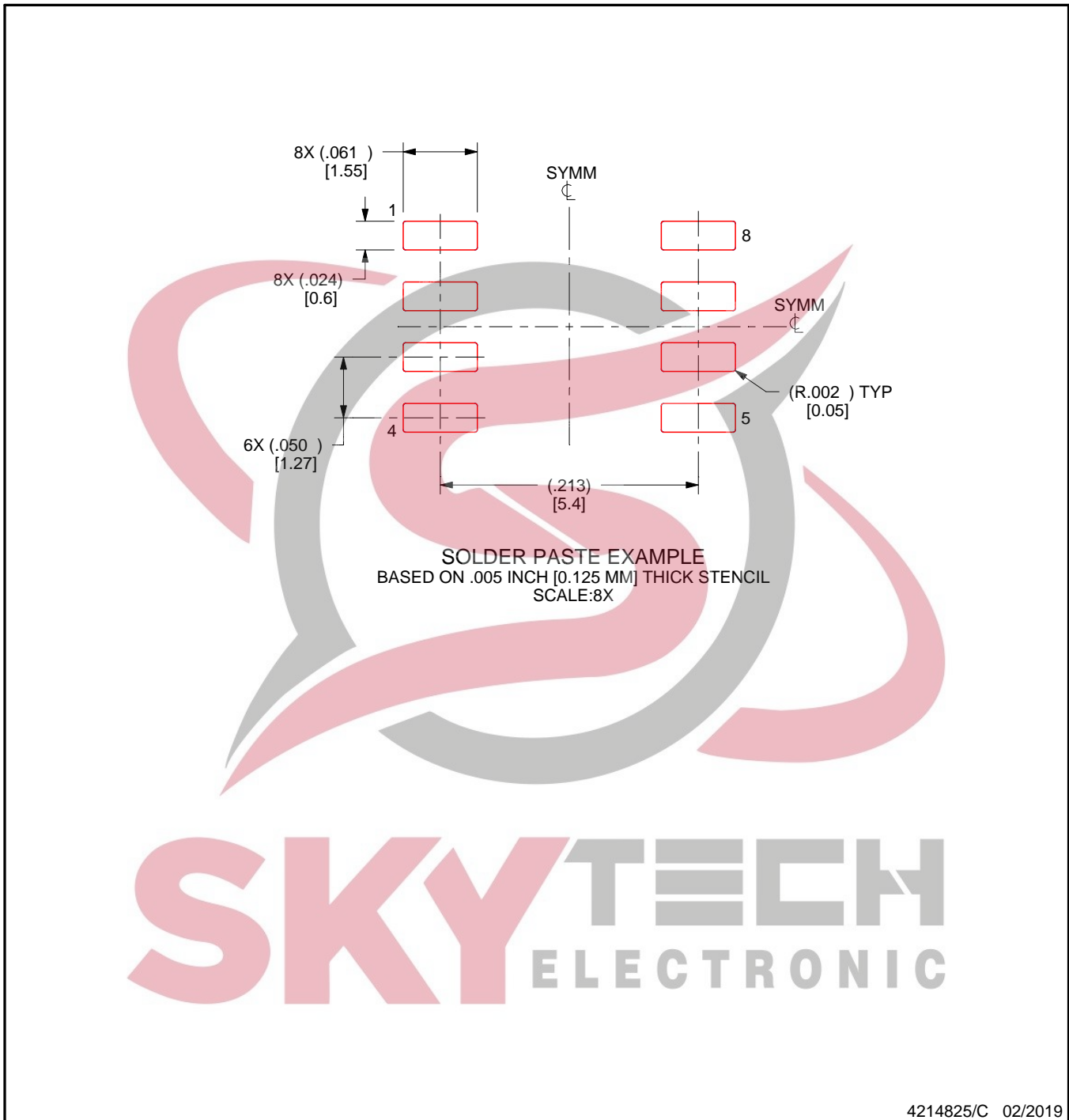

NOTES: (continued)

8. Laser cutting apertures with trapezoidal walls and rounded corners may offer better paste release. IPC-7525 may have alternate design recommendations.
9. Board assembly site may have different recommendations for stencil design.

## IMPORTANT NOTICE AND DISCLAIMER

TI PROVIDES TECHNICAL AND RELIABILITY DATA (INCLUDING DATASHEETS), DESIGN RESOURCES (INCLUDING REFERENCE DESIGNS), APPLICATION OR OTHER DESIGN ADVICE, WEB TOOLS, SAFETY INFORMATION, AND OTHER RESOURCES "AS IS" AND WITH ALL FAULTS, AND DISCLAIMS ALL WARRANTIES, EXPRESS AND IMPLIED, INCLUDING WITHOUT LIMITATION ANY IMPLIED WARRANTIES OF MERCHANTABILITY, FITNESS FOR A PARTICULAR PURPOSE OR NON-INFRINGEMENT OF THIRD PARTY INTELLECTUAL PROPERTY RIGHTS.

These resources are intended for skilled developers designing with TI products. You are solely responsible for (1) selecting the appropriate TI products for your application, (2) designing, validating and testing your application, and (3) ensuring your application meets applicable standards, and any other safety, security, or other requirements. These resources are subject to change without notice. TI grants you permission to use these resources only for development of an application that uses the TI products described in the resource. Other reproduction and display of these resources is prohibited. No license is granted to any other TI intellectual property right or to any third party intellectual property right. TI disclaims responsibility for, and you will fully indemnify TI and its representatives against, any claims, damages, costs, losses, and liabilities arising out of your use of these resources.

TI's products are provided subject to TI's Terms of Sale ([www.ti.com/legal/termsofsale.html](http://www.ti.com/legal/termsofsale.html)) or other applicable terms available either on [ti.com](http://ti.com) or provided in conjunction with such TI products. TI's provision of these resources does not expand or otherwise alter TI's applicable warranties or warranty disclaimers for TI products.

Mailing Address: Texas Instruments, Post Office Box 655303, Dallas, Texas 75265  
Copyright © 2020, Texas Instruments Incorporated



**SKY**TECH  
ELECTRONIC